

MODOMIX SYSTEM



Il sistema MODO-MIX di Master utilizza un unico sistema di supporti per tutti gli apparecchi e le placche. Puoi scegliere gli apparecchi MODO grigio scuro o bianco, MODO STEEL metallizzato, MIX bianco lucido o Retrò. Puoi completare il tuo punto luce con le placche arrotondate MODO, con le placche rettangolari MIX oppure scegliere le finiture speciali della linea VITRA con placche in vetro, metallo, legno, pietra o pelle. Un unico sistema che ti offre infinite possibilità di personalizzazione.



INSERIMENTO FRONTALE O POSTERIORE?

A TE LA SCELTA!

Il sistema **MODO-MIX** di Master utilizza un unico sistema di supporti per tutti gli apparecchi e le placche. Il professionista che installa la serie civile può scegliere tra due linee di supporti, con **inserimento posteriore** o **frontale** degli apparecchi. Le placche e gli apparecchi rimangono gli stessi: cambia solo la modalità di installazione, per assecondare la preferenza di ciascun installatore. Un unico sistema che ti offre infinite possibilità di personalizzazione.

SUPPORTI CON INSERIMENTO POSTERIORE DEGLI APPARECCHI

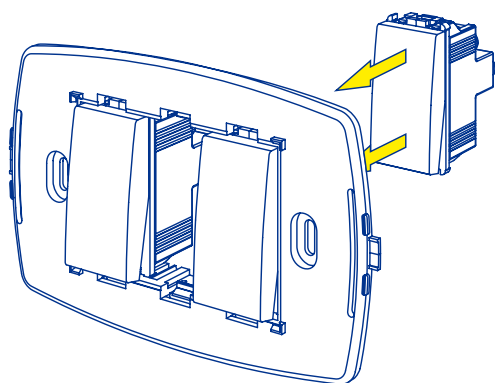

38011

Supporto 1 modulo



38020-1

Supporto 2 moduli



38003

Supporto 3 moduli



38004

Supporto 4 moduli



38007

Supporto 7 moduli

SUPPORTI CON INSERIMENTO FRONTALE DEGLI APPARECCHI

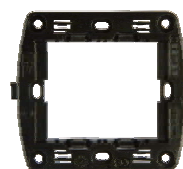
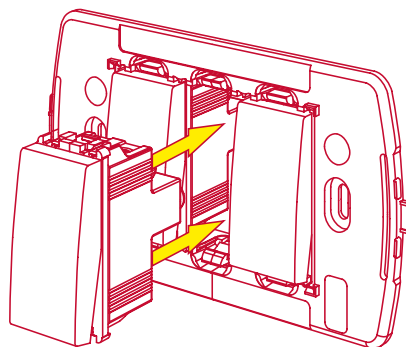

BS28008

Supporto 2/2.5 moduli



38008

Supporto 2 moduli



38003-F

Supporto 3 moduli



38004-F

Supporto 4 moduli



38007-F

Supporto 7 moduli



Scatole supporti e placche

Scatola da incasso

Supporto

Placca

Accessori placca

Apparecchi

1 Modulo

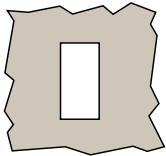

Pareti leggere e pannelli



Placche a 1 modulo
Modo e Mix



È possibile installare tutti gli apparecchi Modo e Mix e Retrò a un modulo.

1+1 Moduli

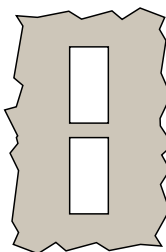

Pareti leggere e pannelli

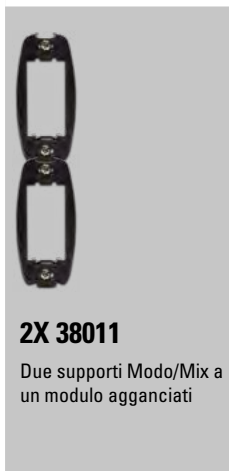

Placche a 1+1 modulo
Modo e Mix



È possibile installare tutti gli apparecchi Modo e Mix e Retrò a un modulo.

MODOMIX SYSTEM

Scatole, supporti e placche

Scatola da incasso	Supporto	Placca	Accessori placca	Apparecchi
--------------------	----------	--------	------------------	------------

2 Moduli



00411 Scatola rotonda Ø 60mm da incasso



00402 Scatola rotonda Ø 60mm per pareti leggere



00418 Scatola quadrata in plastica



38020-I

Supporto agganciabile Modo/Mix a due moduli.



Placche a 2 moduli Modo, Mix e Vitra*, placca monoblocco Mix. Non monta placche Retrò.



Su placca Modo 2 moduli è possibile sostituire l'anello grigio standard con le versioni:
39002 Bianco
39002-FTL Fotoluminescente
39070 con portello fumé
33932 Steel



è possibile installare tutti gli apparecchi Modo e Mix e Retrò a uno o due moduli.

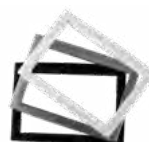

Su placca Vitra 2 moduli è possibile sostituire l'anello cromato standard con le versioni:
21VBS.2 Bianco MIX
33VBS.2 Steel
36VBS.2 Bianco MODO
39VBS.2 Grigio scuro MODO

2 Moduli



00418 Scatola quadrata in plastica



38021

Supporto agganciabile Modo/Mix a due moduli.



Placche a 2 moduli Modo, Mix e Vitra*, placca monoblocco Mix. Non monta placche Retrò.



Su placca Modo 2 moduli è possibile sostituire l'anello grigio standard con le versioni:
39002 Bianco
39002-FTL Fotoluminescente
39070 con portello fumé
33932 Steel



è possibile installare tutti gli apparecchi Modo e Mix e Retrò a uno o due moduli.



Su placca Vitra 2 moduli è possibile sostituire l'anello cromato standard con le versioni:
21VBS.2 Bianco MIX
33VBS.2 Steel
36VBS.2 Bianco MODO
39VBS.2 Grigio scuro MODO

* Le placche Vitra 2 moduli installate su supporti 38020-I o 38021 possono risultare non perfettamente aderenti alla superficie del muro.

Scatole, supporti e placche

Scatola da incasso

Supporto

Placca

Accessori placca

Apparecchi

2 Moduli centrali su scatola 3 moduli

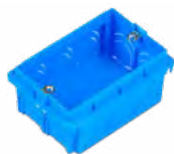

00412 Scatola rettangolare unificata 3 moduli da incasso



00403 Scatola rettangolare 3 moduli per pareti leggere



38008

Supporto Modo/Mix rettangolare a due moduli ad inserimento frontale dei frutti.



Placche rettangolari a 2 moduli tipo 21MX__3-C



è possibile installare tutti gli apparecchi Modo e Mix a uno o due moduli e Retrò.

3 Moduli

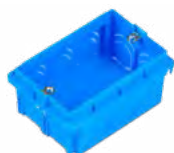

00412 Scatola rettangolare unificata 3 moduli da incasso



00402 Scatola rettangolare 3 moduli per pareti leggere



38003

Supporto Modo/Mix a tre moduli.



38003-F

Supporto Modo/Mix a tre moduli con inserimento frontale dei frutti.

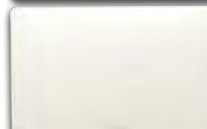

Placche a 3 moduli Modo, Mix, Retrò e Vitra. Placche a 1 modulo centrale e cieca Mix.



Su placca Modo 3 moduli è possibile sostituire l'anello grigio standard con le versioni:
39003 Bianco
33933 Steel
39003-FTL Fotoluminescente
39033 Grigio TLI
39033-B Bianco TLI
33943 Steel TLI



è possibile installare tutti gli apparecchi Modo e Mix a uno, due e tre moduli e Retrò.



Su placca Vitra 3 moduli è possibile sostituire l'anello cromato standard con le versioni:
21VBS.3 Bianco MIX
33VBS.3 Steel
36VBS.3 Bianco MODO
39VBS.3 Grigio scuro MODO

MODOMIX SYSTEM

Scatole, supporti e placche

Scatola da incasso

Supporto

Placca

Accessori placca

Apparecchi

4 Moduli

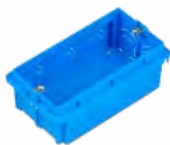

00413 Scatola rettangolare unificata 4 moduli da incasso



00404 Scatola rettangolare 4 moduli per pareti leggere



Scatola rettangolare standard britannico



38004
Supporto Modo/Mix a quattro moduli.



38004-F
Supporto Modo/Mix a quattro moduli con inserimento frontale dei frutti.

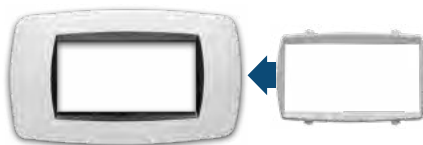

Placche a 4 moduli
Modo, Mix, Retrò e Vitra



Su placca Modo 4 moduli è possibile sostituire l'anello grigio standard con le versioni:
39004 Bianco
33934 Steel
39004-FTL Fotoluminescente
39034 Grigio TLI
39034-B Bianco TLI
33944 Steel TLI



Su placca Vitra 4 moduli è possibile sostituire l'anello cromato standard con le versioni:
21VBS.4 Bianco MIX
33VBS.4 Steel
36VBS.4 Bianco MODO
39VBS.4 Grigio scuro MODO



È possibile installare tutti gli apparecchi Modo e Mix a uno, due e tre moduli e Retrò.

5 Moduli



00414 Scatola rettangolare 5 moduli da incasso



Scatola rettangolare standard britannico



BS28002
Supporto Modo/Mix a 5/5.5 moduli.



Placche a 5 moduli
Modo



Su placca Modo 5 moduli è possibile sostituire l'anello grigio standard con la versione bianca:
39005 Bianco



È possibile installare tutti gli apparecchi Modo e Mix a uno, due e tre moduli e Retrò.

Scatole supporti e placche

Scatola da incasso

Supporto

Placca

Accessori placca

Apparecchi

7 Moduli



00416 Scatola rettangolare
6/7 moduli da incasso



00406 Scatola rettangolare
6/7 moduli per pareti leggere



38007
Supporto Modo/Mix
a sette moduli.



38007-F
Supporto Modo/Mix
a sette moduli con inserimento
frontale dei frutti.



Placche a 7 moduli
Modo, Mix, Retrò e Vitra



Su placca Modo 7 moduli
è possibile sostituire
l'anello grigio standard
con le versioni:
39007 Bianco
33937 Steel
39007-FTL Fotoluminescente
39037 Grigio TLI
39037-B Bianco TLI
33947 Steel TLI



Su placca Vitra 7 moduli è
possibile sostituire l'anello
cromato standard
con le versioni:
21VBS.7 Bianco MIX
33VBS.7 Steel
36VBS.7 Bianco MODO
39VBS.7 Grigio scuro MODO



è possibile installare tutti
gli apparecchi Modo e Mix
a uno, due e tre moduli
e Retrò.

2+2 Moduli

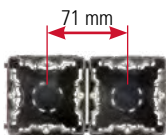
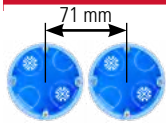

2 scatole tonde **00402/00411** o
quadrate **00418** affiancate



00414 Scatola rettangolare
5 moduli da incasso



38005
Supporto Modo/Mix
a 2+2 moduli reversibile.



2x 38002-I
Supporto agganciabile Modo/Mix



2x 38021
Supporto agganciabile Modo/Mix



38005
Supporto
Modo/Mix
a 2+2 moduli
reversibile.
Permette di
agganciare gli
apparecchi con
orientamento
orizzontale o
verticale.



Placche a 2+2 moduli
Modo e Mix



Su placca Modo 2+2 moduli
è possibile sostituire l'anello
grigio standard
con le versioni:
39002 Bianco
39002-FTL Fotoluminescente
39070 con portello fumé
33932 Steel



è possibile installare tutti
gli apparecchi Modo e Mix
a uno, due e tre moduli
e Retrò.



MODOMIX SYSTEM

Scatole supporti e placche

Scatola da incasso

Supporto

Placca

Accessori placca

Apparecchi

2+2+2 Moduli, installazione orizzontale

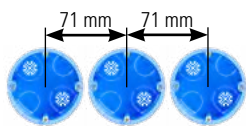

3 scatole tonde **00402/00411** affiancate



3x 38020-I ①
Supporto agganciabile
Modo/Mix a due moduli.



38005 + 38020-I ①
Supporto 2+2 moduli Modo/Mix
agganciabile e reversibile con
un supporto 2 moduli



Placche a 2+2+2 moduli
Modo e Mix



Su placca Modo 2+2+2 moduli è possibile sostituire l'anello grigio standard con le versioni:
39002 Bianco
39002-FTL Fotoluminescente
39070 con portello fumé
33932 Steel



è possibile installare tutti gli apparecchi Modo e Mix e Retrò a uno o due moduli.

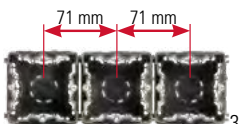

3 scatole quadrate **00418** affiancate



3x 38021 ①
Supporto agganciabile
Modo/Mix a due moduli.

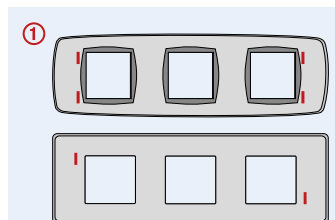

Rimuovere gli agganci evidenziati per l'installazione

2+2+2 Moduli, installazione verticale

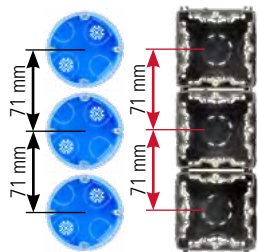

3 scatole tonde **00402/00411** o quadrate **00418** in verticale



38005 + 38020-I ②
Supporto 2+2 moduli
Modo/Mix con un supporto 2 moduli



Placche a 2+2+2 moduli
Modo e Mix



Su placca Modo 2+2+2 moduli è possibile sostituire l'anello grigio standard con le versioni:
39002 Bianco
39002-FTL Fotoluminescente
39070 con portello fumé
33932 Steel



è possibile installare tutti gli apparecchi Modo e Mix e Retrò a uno o due moduli.

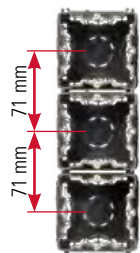

3 scatole quadrate **00418** in verticale



3x 38021
Supporto agganciabile
Modo/Mix a 2 moduli



Rimuovere gli agganci evidenziati per l'installazione

Scatole supporti e placche

Scatola da incasso

Supporto

Placca

Accessori placca

Apparecchi

2+2+2+2 Moduli, installazione orizzontale

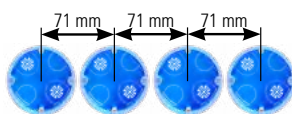

4 scatole tonde **00402/00411** affiancate



4x 38020-I ^③
Supporto agganciabile
Modo/Mix a due moduli.



2x 38005 ^③
Supporto 2+2 moduli Modo/Mix
agganciabile e reversibile



4x 38021
Supporto agganciabile
Modo/Mix a due moduli.



Placche a 2+2+2+2 moduli
Modo e Mix



Su placca Modo
2+2+2+2 moduli è
possibile sostituire
l'anello grigio standard
con le versioni:
39002 Bianco
39002-FTL
Fotoluminescente
39070 con portello
fumé
33932 Steel



è possibile installare
tutti gli apparecchi
Modo e Mix e Retrò
a uno o due moduli.

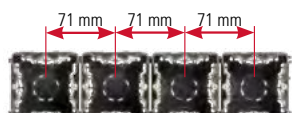

4 scatole quadrate **00418** affiancate

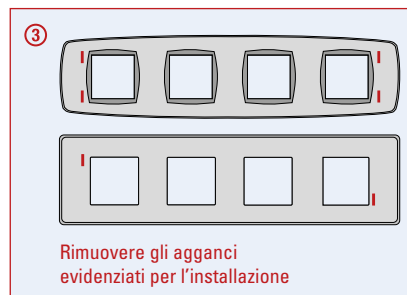

2+2+2+2 Moduli, installazione verticale

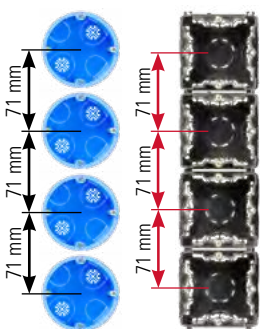

4 scatole tonde **00402/00411** o
quadrate **00418** in verticale



2x 38005 ^③
Supporto 2+2
moduli Modo/Mix
agganciabile e
reversibile



4x 38021
Supporto
agganciabile
Modo/Mix
a 2 moduli



Placche a 2+2+2+2 moduli
Modo e Mix



Su placca Modo 2+2+2+2
moduli è possibile sostituire
l'anello grigio standard con le
versioni:
39002 Bianco
39002-FTL Fotoluminescente
39070 con portello
fumé
33932 Steel



è possibile installare tutti gli
apparecchi Modo e Mix e
Retrò a uno o due moduli.

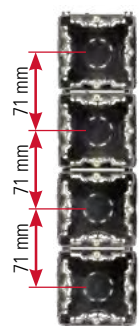

4 scatole quadrate **00418** in
verticale

MODOMIX SYSTEM

Scatole supporti e placche

Scatola da incasso

Supporto

Placca

Apparecchi

12 Moduli



Scatola da incasso rettangolare 12 moduli **00417**



38012
Supporto Modo/Mix a 12 moduli.



Placche Mix a 12 moduli



è possibile installare tutti gli apparecchi Modo e Mix a uno, due e tre moduli e Retrò.

24 Moduli



Scatola da incasso rettangolare 24 moduli (2 scatole 12 moduli **00417** combinate)



2x 38012
Supporto Modo/Mix a 12 moduli.



Placche Mix a 24 moduli



è possibile installare tutti gli apparecchi Modo e Mix a uno, due e tre moduli e Retrò.

Applicazioni speciali per British Standard

Scatola da incasso

Supporto

Placca

Accessori placca

Apparecchi

2 Moduli BS



Scatola quadrata in metallo



BS38002
Supporto BS per Modo/Mix a 2/2.5 moduli.



Placche a 2 moduli MixBS e Vitra.



Su placca Vitra 2 moduli è possibile sostituire l'anello cromato standard con le versioni:
21VBS.2 Bianco MIX
33VBS.2 Steel
36VBS.2 Bianco MODO
39VBS.2 Grigio scuro MODO



è possibile installare tutti gli apparecchi Modo e Mix a uno e due moduli.

Applicazioni speciali per British Standard

Scatola da incasso	Supporto	Placca	Accessori placca	Apparecchi
--------------------	----------	--------	------------------	------------

2.5 Moduli BS



Scatola quadrata in metallo



BS38002
Supporto BS per Modo/Mix a 2/2.5 moduli.



Placche a 2.5 moduli MixBS e Vitra.



Su placca Vitra 2.5 moduli è possibile sostituire l'anello cromato standard con le versioni:
21VBS.25 Bianco MIX
33VBS.25 Steel
36VBS.25 Bianco MODO
39VBS.25 Grigio scuro MODO



è possibile installare gli apparecchi MixBS a 2,5 moduli.

5 Moduli BS



Scatola rettangolare in metallo, standard britannico



BS38005
Supporto BS per Modo/Mix a 5/5.5 moduli.

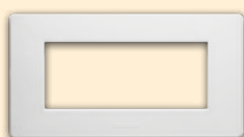

Placche a 5 moduli MixBS e Vitra.



Su placca Vitra 5 moduli è possibile sostituire l'anello cromato standard con le versioni:
21VBS.5 Bianco MIX
33VBS.5 Steel
36VBS.5 Bianco MODO
39VBS.5 Grigio scuro MODO



è possibile installare gli apparecchi Modo e Mix a uno, due e tre moduli e MixBS a 5 moduli.

5.5 Moduli BS



Scatola rettangolare in metallo, standard britannico



BS38005
Supporto BS per Modo/Mix a 5/5.5 moduli.

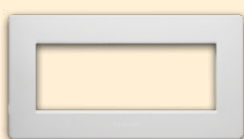

Placche a 5.5 moduli MixBS e Vitra.



Su placca Vitra 5 moduli è possibile sostituire l'anello cromato standard con le versioni:
21VBS.55 Bianco MIX
33VBS.55 Steel
36VBS.55 Bianco MODO
39VBS.55 Grigio scuro MODO



è possibile installare gli apparecchi MixBS a 5.5 moduli.

! Master assicura il corretto funzionamento dei propri dispositivi unicamente quando viene rispettata la corretta combinazione di installazione tra supporti, apparecchi e placche Master.
■ Altre soluzioni e adattamenti possono compromettere la funzionalità e sicurezza dei prodotti.

MODOMIX SYSTEM

Supporti per MODO, MIX e Retro



38020-I

Supporto per MODO e MIX 2 posti Universale, agganciabile, con graffe, per scatola tonda



38021

Supporto per MODO e MIX, 2 posti agganciabile e reversibile, per scatola quadrata



38005

Supporto per MODO e MIX 2+2 posti reversibile e agganciabile, con viti



38008

Supporto per MODO e MIX 2 posti centrali ad inserimento frontale, con viti, per scatola 3 moduli



38003

Supporto per MODO e MIX 3 posti, con viti



38004

Supporto per MODO e MIX 4 posti, con viti



38007

Supporto per MODO e MIX 7 posti, con viti



38003-F

Supporto per MODO e MIX 3 posti ad inserimento frontale, con viti



38004-F

Supporto per MODO e MIX 4 posti ad inserimento frontale, con viti



38007-F

Supporto per MODO e MIX 7 posti ad inserimento frontale, con viti



BS28000 

Supporto per MODO e MIX 2 e 2,5 moduli ad aggancio frontale, con viti, per scatole in metallo British standard



BS28002 

Supporto per MODO e MIX 5 e 5,5 moduli ad aggancio frontale, con viti, per scatole 5 moduli



38012

Supporto per MODO e MIX 12 posti (6+6), con viti, agganciabile
2 supporti combinati consentono di ottenere il supporto a 24 posti (6+6+6+6) per le apposite placche MIX.



38011

Supporto per MODO e MIX per pareti leggere 1 posto, agganciabile, con viti



43801

Supporto per guida Din 1 modulo, Grigio RAL 7035



43802

Supporto per guida Din 2 moduli, Grigio RAL 7035



38050-20

Confezione da 20 viti lunghezza 50mm per fissaggio supporti su scatole da incasso sotto il filo-muro.

 Disponibile fino ad esaurimento scorte.