

Art. **BS21109-I • BS24109 • BS26109 • BS27109**
2P+E 15A switched socket outlet, BS standard

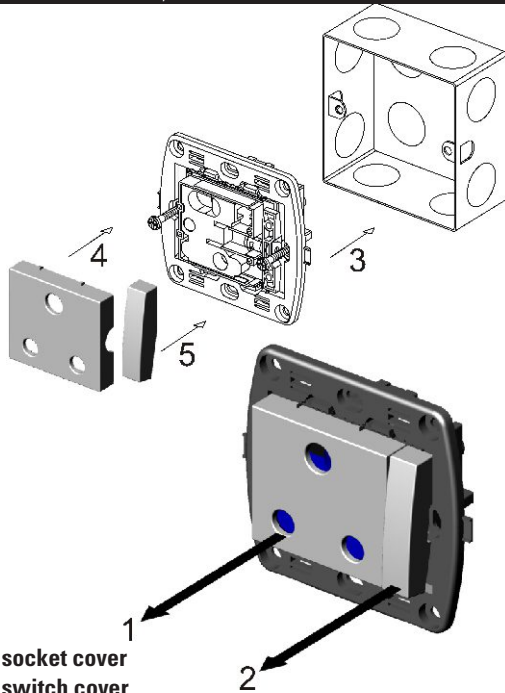

1. Remove the socket cover
 2. Remove the switch cover
 3. Fix the device to the wall box using the proper screws
 4. Place back the socket cover on its place
 5. Place back the switch cover on its place
- Then, fix the frame on the device

MADE
IN ITALY

31SL.MANUALE49

Art. **BS21109-I • BS24109 • BS26109 • BS27109**
2P+E 15A switched socket outlet, BS standard

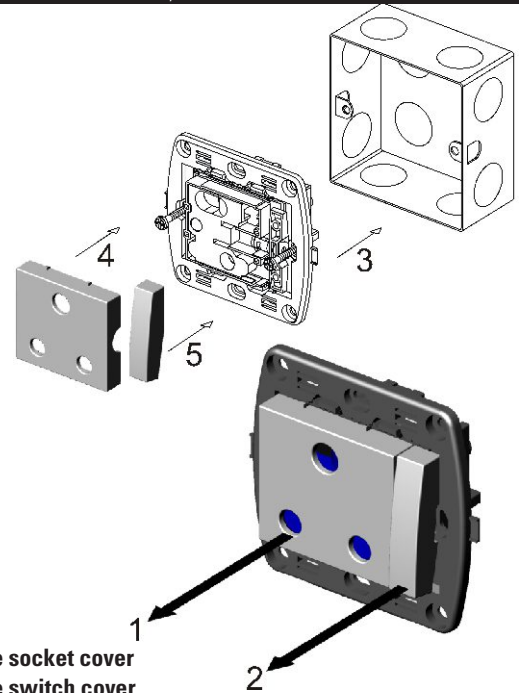

1. Remove the socket cover
 2. Remove the switch cover
 3. Fix the device to the wall box using the proper screws
 4. Place back the socket cover on its place
 5. Place back the switch cover on its place
- Then, fix the frame on the device

MADE
IN ITALY

31SL.MANUALE49

Art. **BS21109-I • BS24109 • BS26109 • BS27109**
2P+E 15A switched socket outlet, BS standard

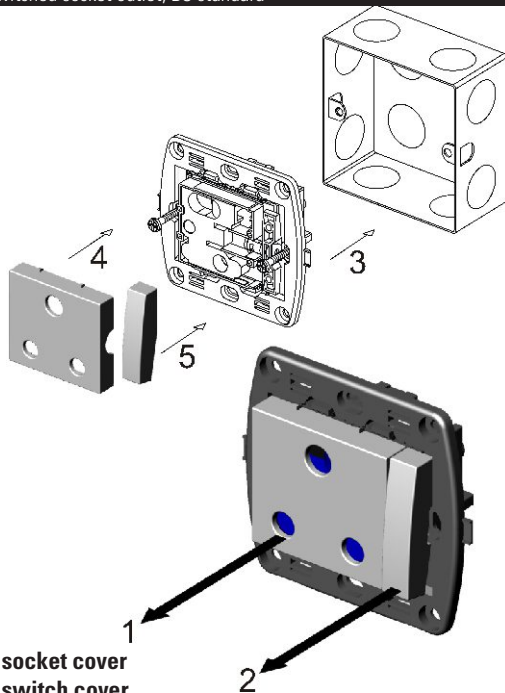

1. Remove the socket cover
 2. Remove the switch cover
 3. Fix the device to the wall box using the proper screws
 4. Place back the socket cover on its place
 5. Place back the switch cover on its place
- Then, fix the frame on the device

MADE
IN ITALY

31SL.MANUALE49

Art. **BS21109-I • BS24109 • BS26109 • BS27109**
2P+E 15A switched socket outlet, BS standard

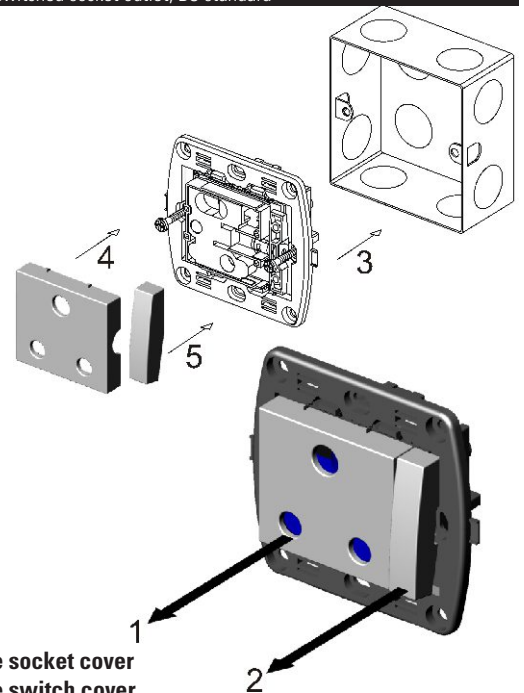

1. Remove the socket cover
 2. Remove the switch cover
 3. Fix the device to the wall box using the proper screws
 4. Place back the socket cover on its place
 5. Place back the switch cover on its place
- Then, fix the frame on the device

MADE
IN ITALY

31SL.MANUALE49