



USER MANUAL

UNA AUTOMATION

MASTER
LIVING TECHNOLOGY



Contents

UNA BOARD.....	5
UNA THERMOSTAT.....	6
DIFRA BOARD.....	7
VISUS/TOSCA.....	8
Start Up.....	8
Home.....	8
Maps.....	9
Elements.....	9
Programmable Elements.....	10
Visus/Tosca Menu.....	15
Security Manager.....	21
Difra Access Control.....	25
SIDERA HOME.....	31
SideraHome Menu.....	31
SIDERA WEB.....	36
SideraWeb Menu.....	36
.....	40

UNA BOARD

UNA system modules independently develop all the functions necessary to manage a plant: each module has its own control logic, dedicated inputs and power outputs, main power supply and a backup.

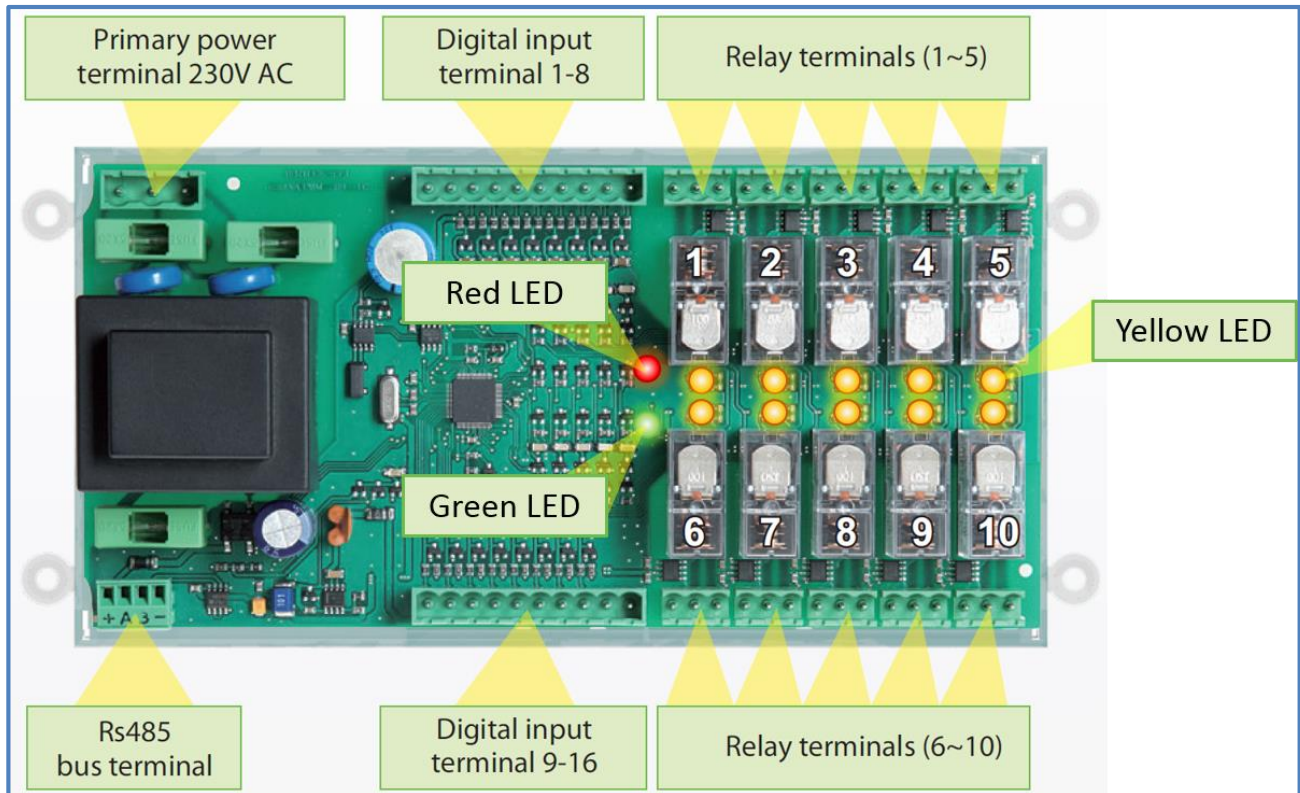

Figure 1.

For identifying the correct operation of the UNA system modules, every module have on board three types of LEDs that indicate the state of the device.

These LEDs are:

- Red and green LEDs: they indicate the state of the module. If the red LED is on and the green LED is flashing at one-second frequency, the UNA board is correctly powered and running. When the red LED is off, that means that there is not power or the fuses inside the board are blown.
- Yellow LEDs: these indicate the state of the relay, when it is on the relay is turned on.

Troubleshooting

If the board is powered and the red LED remains off, you must ensure that:

- Wiring is correct and there is voltage between 200 – 250 Vac in the power terminal (P and N of the primary power terminal);
- The three fuses have not blown. If is necessary, replace them with fuses of the same features.

If the relay output is not working, you must ensure that:

- The yellow LED turns on or turns off according to the associated command and ensure that the relay contact turns.

If the devices still do not work, please contact the installer for checking the functionality of the boards and eventually replace them with new ones.

UNA THERMOSTAT

The UNA Thermostat is used for room climate control. The temperature can be viewed and required operating mode set on this device.

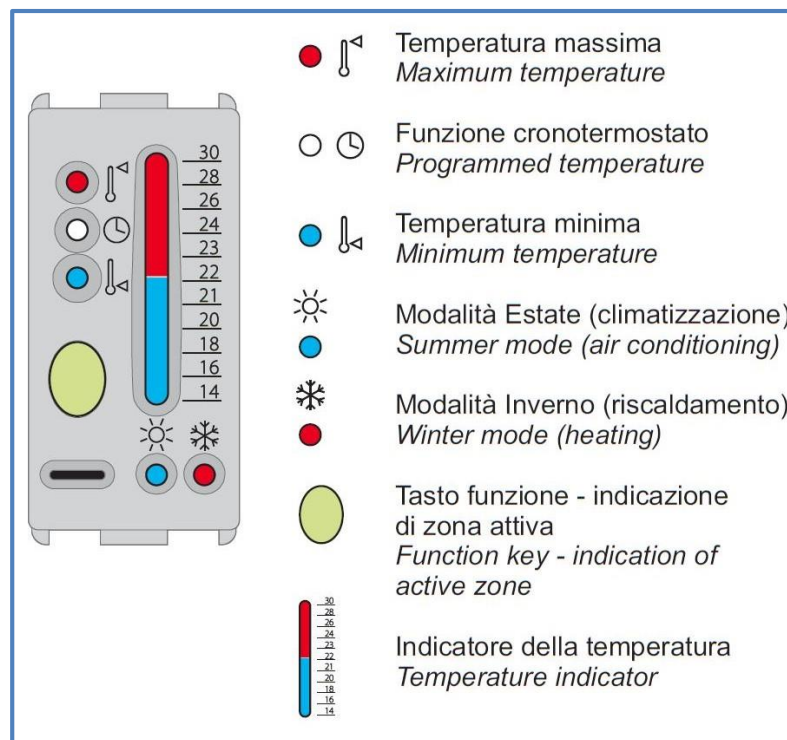

Figure 2. UNA Thermostat.

Function description:

- Minimum temperature (blue led, thermometer icon): maintains the minimum temperature set;
- Maximum temperature (red led, thermometer icon): maintains the maximum temperature set;
- Thermostat timer (white led, clock icon): weekly thermostat time function with hourly settings for each day.

Selection modes:

- Short key touch: the thermostat restarts from standby and displays the temperature;
- Next short key touches: touch to change functions (in sequence they are: Off – MIN Temp. – Thermostat timer – MAX Temp.);
- Long-touch key: lets you switch from SUMMER to WINTER mode and vice versa;
- Back-lit green key: indicates that the zone is on, thus heating or cooling is running, in real-time.

For setting minimum, maximum temperature and weekly program you must operate by VISUS (Tosca) or SideraHome.

DIFRA BOARD

Difra is the UNA System's custodian. It can guarantee you to your space, privacy and all the assistance you may need.

Difra allows you to control access in a residential, hotel or service environment through cards equipped with RFID devices, supplying differentiated signals to the outside. Difra has two relay outputs designed to command and electrical lock and a courtesy light, where applicable.



Programming without PC

For a quickly programming, if Difra board is correctly power supplied and there are not badge cards saved in their memory, you can associate the badge cards to Difra board simply placing the cards on the board.

- **Main Badge Card 1:** it is the first card to be saved. Place the badge card on the RFID reader and wait until the green LED light "on" stays on for 5 seconds. Now the first badge card has been associated to the badge reader as master badge card. It is enabled to every access and the association with new badge cards.
- **Main Badge Card 2:** it is the second badge card to be saved and it has the same properties of Main Badge card 1. Place Main Badge card 1 to RFID reader, as soon as the green LED light starts flashing, please remove the Main badge card 1 and place the new badge on Difra. When the green LED light "on" stays on for 5 seconds, the new association has happened. If (after 15 seconds) the association has not been completed, it will be necessary to repeat the operation.
- **Further Cards:** Once you have associated the Main badge cards, the other badge cards will be: the two Cards for Hotel's Staff and the following Guests' Cards. You must have a Main badge card to place on the RFID reader, when the green LED "on" starts flashing, please place the new badge card on the reader.
- **Deleting Guest cards:** put the badge on the RFID reader, when the green LED light "entrance" is flashing, put on the RFID reader one of the Main badge cards. When the green LED light "entrance" is flashing alternating green and red color, that means the operation has been completed.
NOTE: when you delete a badge card from DIFRA, the badge cards lately saved rise one position and play the role of the previous badge.
- **Deleting saved cards:** in order to completely delete all the badge cards saved on DIFRA reader, put **Main badge card 1** and then **Main badge card 2** as soon as the green LED light "entrance" is flashing. If the green LED "entrance" is flashing red and green, that means the operation has been done.

VISUS/TOSCA

Visus/Tosca can grant you the control and management of all devices connected to the UNA System in real time, allowing for the navigation, interaction and the control of the whole system from a single point.

Visus/Tosca updates in real time when devices are enabled or disabled by other command points. Finally, it is equipped with additional application that allow for control of stand-by and energy saving.

Start Up

The initial screen shown below appears when Visus/Tosca is on. Touch this screen to open system management tools.



Figure 3.

Home

If the system was correctly set up, the Robot Logo eyes at the right bottom of the screen has to turned bright green. If this is not the case, make sure that:

- Vesta is running and connected to the network; also, try to reboot the board.
- Visus/Tosca is connected to the same network of Vesta; double check the network status and the configuration parameters in "Manage" – "Settings" – "Network". On the "Status" page, make sure of the "Connected" status with a correct IP address (compatible with the local router and not allocated to another device). If Visus/Tosca is connected, try to disconnect it and then connect it again.

In case it has a bad IP address, in "Properties" page allocate a right static IP address (Tosca and Vesta need to be into the same subnet). If you are not sure, leave a dynamic IP address (DHCP option).

Several seconds after turning on the touch screen, Tosca will connect to the Vesta board and download all the information required to control UNA series installed in the plant.

From this screen (Figure 4) you can navigate and interact with the various system maps using the displayed element icons. You can also navigate through elements using the list on the right side of the maps which controls groups by type. If the list is not displayed, touch the "List" button at the bottom of the screen.



Figure 4.

You can also open other functions using the menu at the bottom.

Maps

The domotics system is navigated using Maps which represent system areas.

Please note that maps are organised in a tree graph where one map will be the root, meaning the main map, which will have branch maps which, in turn, will have their branch maps and so on.

Is possible navigate maps using the "List", select the required map by touching one of them on the preview screen or, for maps displayed full screen, use the specific icons.

When a map is showing in full screen and you want to navigate on the same level: drag a map to the right or the left to view the previous or next map. But, if you want navigate to the upper level: drag the map upwards to open the map on the upper level or press the "Back" button.

Elements

You can interact with the domotics system through Elements, represented by blocks in Maps, or using the previously described list that groups them by category. Some examples of categories are:

- Commands;
- Difra;
- Lighting;
- Cameras;
- Shutters;
- Thermostats.

New categories can be added by updated Visus/Tosca.

To interact with an Element, first select it by touching its icon so that it is highlighted (the icon is enlarged, Figure 5) and then you can interact with element by simply touching them.

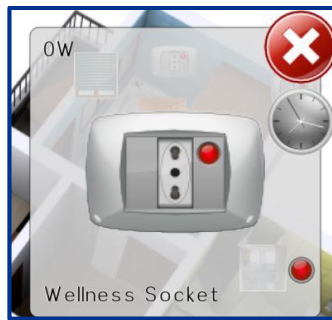

Figure 5.

Each Element is linked to an icon that changes according to the object's status. For a socket, for example, a red led will turn green if the socket is on and turn red if it is off.

Programmable Elements

Some elements in Maps provide specific setting tools.

Heat regulation



Touch a "Thermostat" type icon in a Visus/Tosca map. The corresponding control window will be displayed as shown in Figure 6.



Figure 6.

The temperature currently read by the thermostat is displayed in the middle of the window.



Four buttons are found on the left to set thermostat operating modes. Available operating modes are:

	TMax: maintains the maximum temperature set.
	Thermostat timer: weekly thermostat time function with hourly settings for each day.
	TMin: maintains the minimum temperature set.





	<p>Off: zone valves are kept off.</p>
---	--

Operating season control buttons are found at the bottom right:

	<p>Winter: the thermostat will activate heating associated zone if needed.</p>
	<p>Summer: the thermostat will activate cooling associated zone if needed.</p>

The icon on the right provides information on zone valve status:

	<p>The associated zone is not running.</p>
	<p>The associated zone is running.</p>

Temperature and thermostat timer parameter setting

To set temperature parameters, touch the "Wrench" button in the thermostat control panel. The settings interface is shown in Figure 7. "Plus/minus" button are displayed at the bottom left to set the limit value for TMin mode. On the right, the similar buttons are displayed to set temperature for Tmax mode.

The graph displayed in the middle concerns "Thermostat timer" mode. The days of the week are displayed at the top: touch a day to display the corresponding temperature graph where temperatures are shown on the vertical axis and the time of day on the horizontal axis. Hourly temperatures can be changed by dragging the corresponding points. Two blue and grey icons are displayed at the bottom of the graph and correspond to the "defrost" mode temperature limit and zone off limit respectively.

Once one day is set, programming can be copied to other days by "Copy" tool.

When finished setting the thermostat, touch save to apply settings. To cancel changes, touch the exit without saving button.

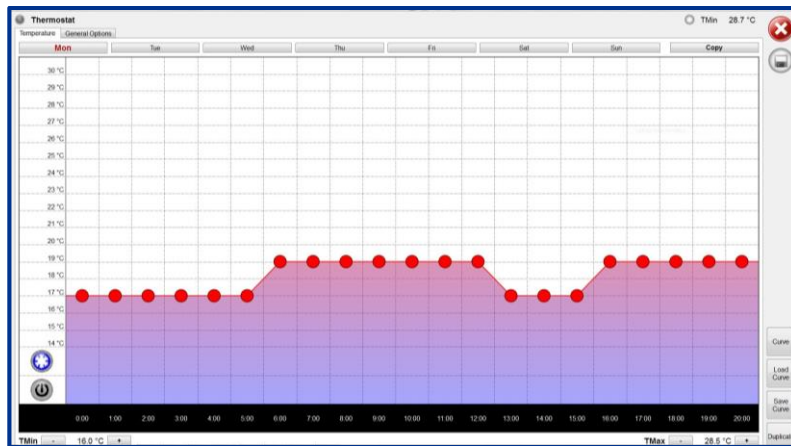

Figure 7.

Scenarios timer

The scenario timer allows you to set in which days of the year and during which times a given scenario must be active.



Figure 8.

Selecting the icon of scenario timer, you can open the editor whereby you can set the timings of the week/year.

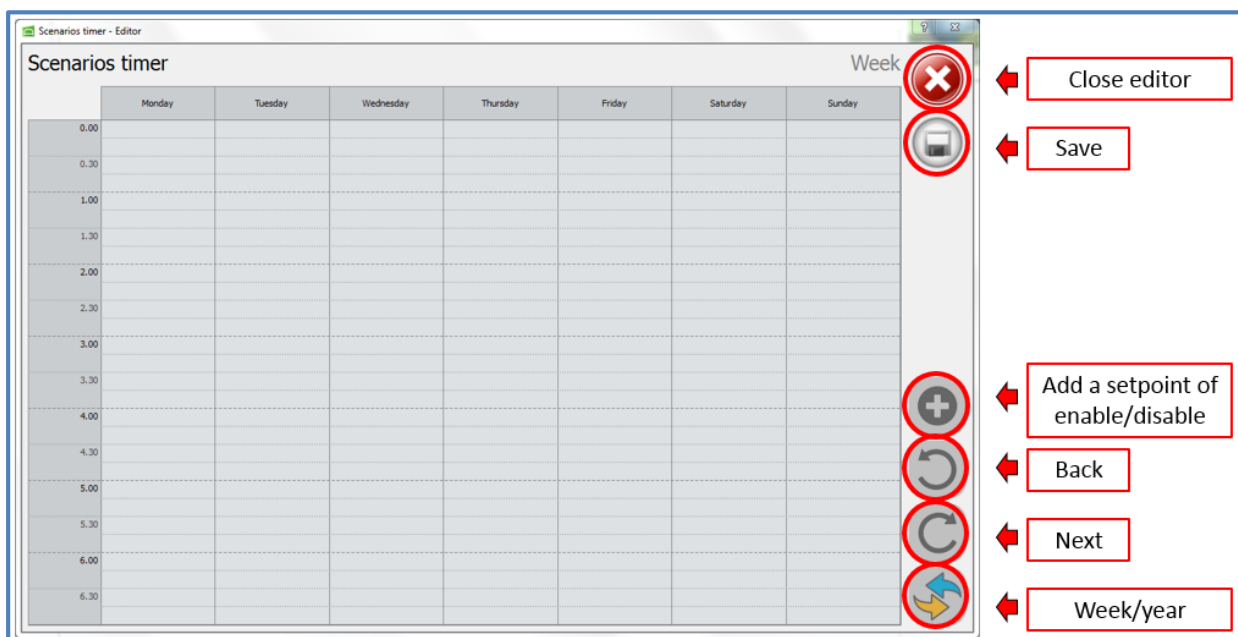

Figure 9. Scenario timer editor.



In the screen that is displayed, you can:

- Close the editor;
- Save the configurations set;
- Add setpoints of enable/disable;
- Delete the last operation made;
- Return at the next operation;
- Switch from WEEK to YEAR days in which to active the scenario timer.

To set an activation period of the scenario timer, you must create two set points, the first for activation and the second for deactivation. The period in which the scenario timer is running is highlighted by a colourful banner.

For creating a setpoint, you must:

1. Touch on the "Plus" icon on the right sidebar of the screen;
2. Select the toolbar that appears in the middle of the screen;
3. Touch the wrench that appear on the left.

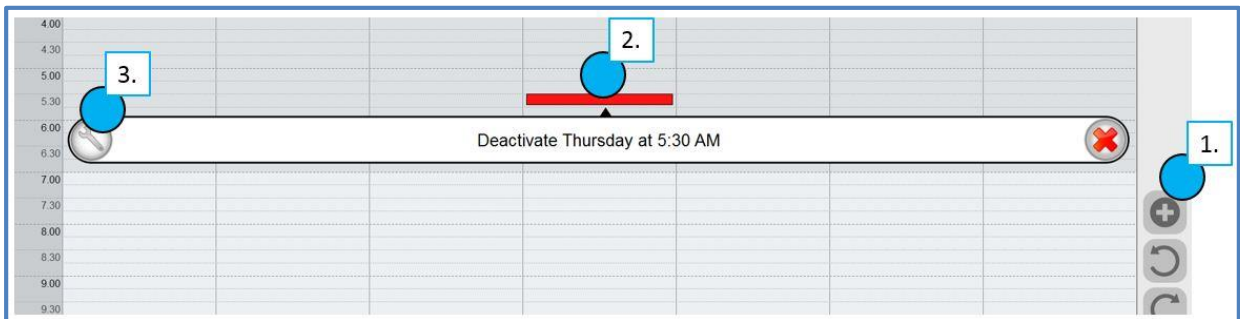

Figure 10. Create a setpoint.

At this point, the following screen will appear.

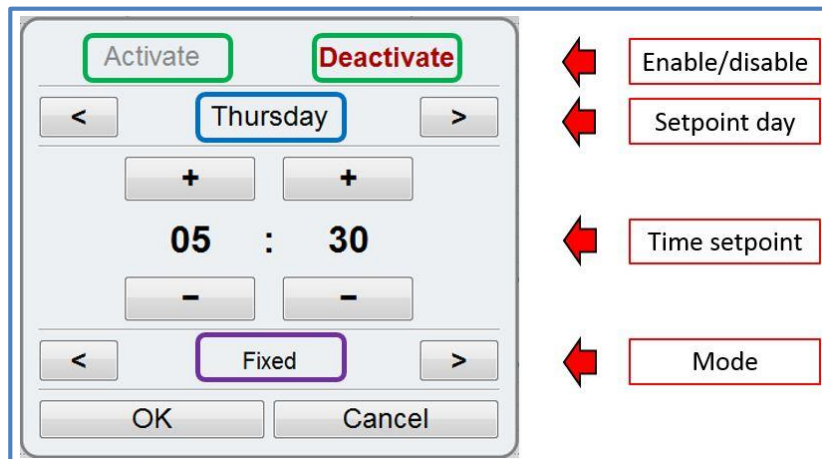

Figure 11. Setpoint screen.

Depending on the type of setpoint, you can set:

- If it is to be enabled or disabled;
- Day of the week;
- Hour;
- Mode: "Fixed", "Before sunrise", "After sunrise", "Before sunset" and "After sunset".

Example

We will create a scenario timer that will activate one hour after sunrise and deactivate one hour before sunset. It will run every day of the week for every day of the year.

We create a new activation setpoint, where we select “Activate”, on “Monday”, time “01:00” and as mode “After sunrise”. The next step, we create a deactivation setpoint, which is “Deactivate”, on “Monday”, time “01:00” and as mode “Before sunrise”.

At this point, these operations are repeated to fill the entire week.

The last step is verifying that the scenario timer is active for every day of the year: by typing on the key the right button “Week/Year” we pass to view the months, as shown in the next figure. In the screen that appears every day of the year should be highlighted.

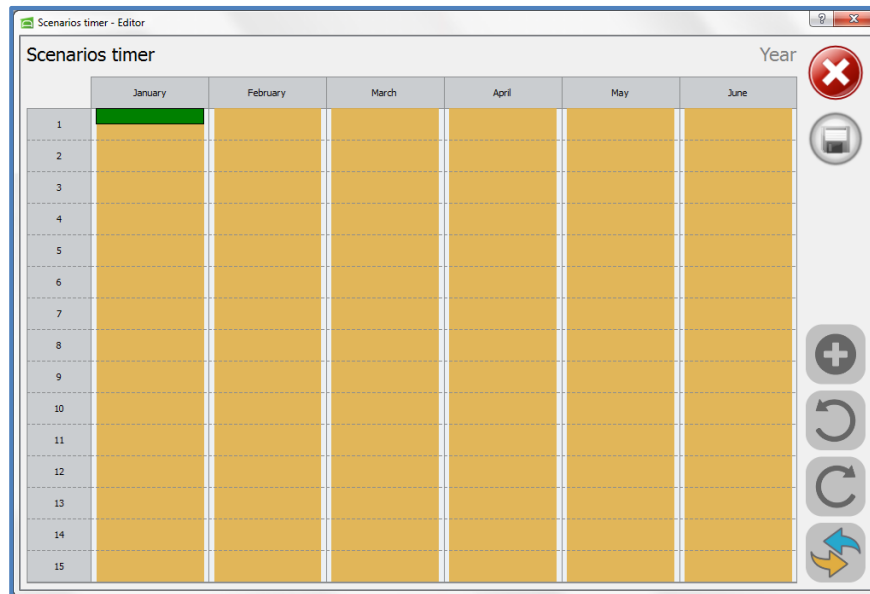

Figure 12.

You can change the days of the year in which to activate the timer, working in a similar mode to the previous one.

By default the timer is running every day of the year.

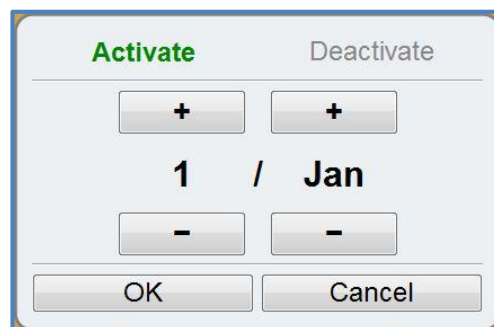

Figure 13.



Visus/Tosca Menu

Touch the UNA logo at the bottom right (Figure 4) to open the pop-up menu on two rows containing the menu (lower part) and its sub-menu.

Control

This lets you control the domotics system by displaying Maps and Elements.

Home	Let's you return to the project Home page and display all maps.
List	This show or hide the Element List for a more accurate view of the figure in question.
Back	Press to return to the previous screen.
Reload	Press to reload the entire project. It is useful when, for example, connection with Vesta is lost due to network problems.

Manage

This menu items lets you open the home system consumption section (Figures 14 and 15).

The sub-menu of the "Manage" menu includes: "Consumption", "Consumption queries", "Rules Editor" and "Settings".

Consumption

The fields show represent the consumption of the various EVA POWER boards installed in the system.

Each field can display four different types of data by pressing the four buttons at the top right of each field:

Real-time consumption	The last values directly read by EVAPOWER boards are displayed. Real time consumption is displayed as horizontal bars.
Hourly consumption	Consumption is displayed for the last 24 hours divided by element (Figure 15).
Daily consumption	Consumption is displayed for the last 30 days divided by element.
Monthly consumption	Consumption is displayed for the last 12 months divide by element.



Figure 14.

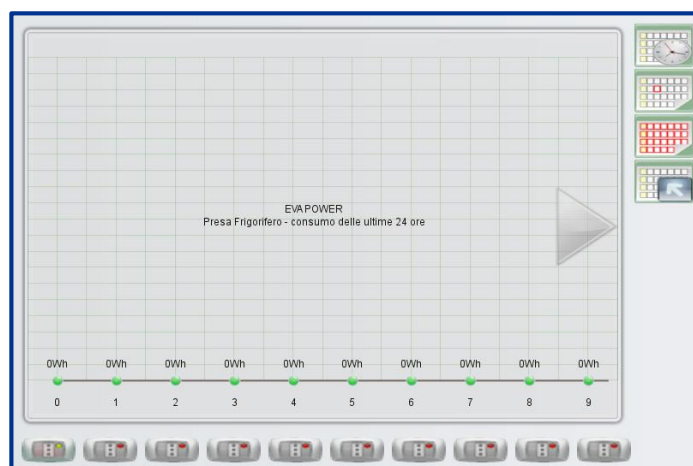

Figure 15.

Consumption queries

Furthermore, touch "Consumption queries" to query the Vesta database using the specific tool (Figure 16).

This window lets you create queries for the database and obtain and view the results.

First select a board from the list on the left.

Afterwards, select the Elements connected to this board to query its statistics. At this point you can query the database for hourly or weekly element consumption.

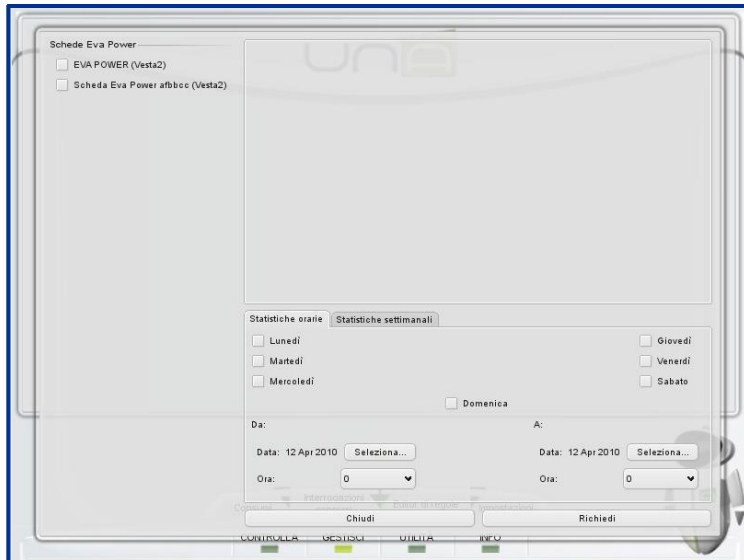

Figure 16.

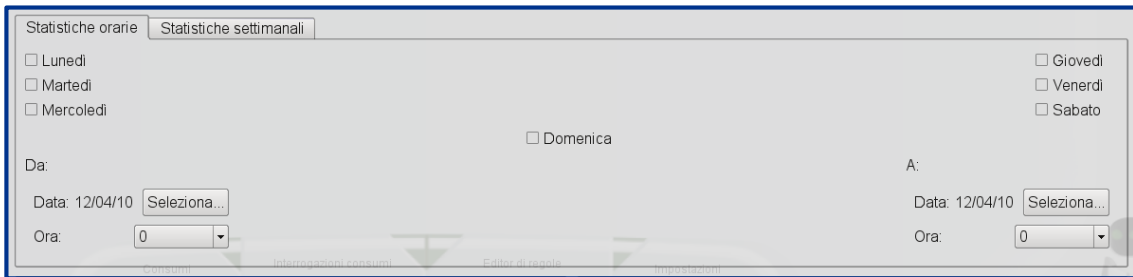

Figure 17.

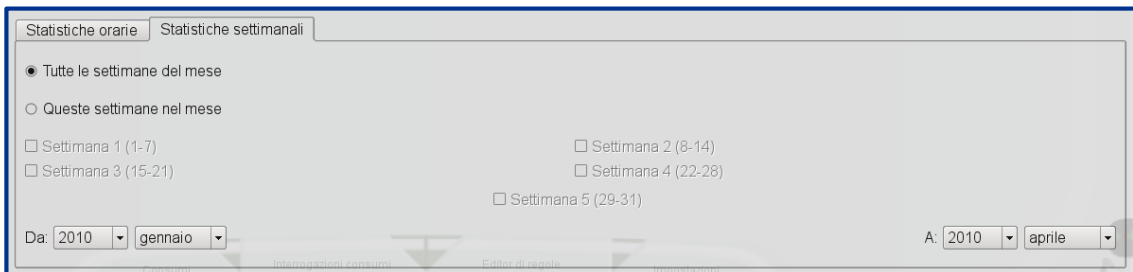

Figure 18.







As for hourly consumption (Figure 17), select the days of interest by flagging the boxes for the required days of the week. After selecting the days, select the time interval using the two "Select" buttons in the "From:" and "To:" section and the time interval to take into account for each day using the multiple choice boxes further below. Once the parameters are selected, press "Query" and wait until the results are displayed in a box similar to the one previously described to view hourly consumption for a board.

Weekly consumption parameters (Figure 18) are selected the same way as the ones above.

Rules editor

In Rules Editor you can display scenarios (or rules) implemented in Vesta board by the installer and allow him to create other scenarios.

In the Elements list, all the objects in the project are contained. Selecting a category, a drop-down menu will open, where there is an alphabetical order list with all the objects belonging to that category. Selecting an element, all the events and all the actions about that element will be displayed.

	You can display/ hide the scenarios saved in the system.
	You can display/hide the scenarios implemented by the user.
	Update scenarios list
	You can send the edited scenarios from the user to the system loads them for the execution.
	If pressed, it allows the execution of scenarios, both implemented by the user and those present in the system.
	If pressed, it disables the execution of scenarios.

In order to create a scenario, please go to “Scenarios list”, press “select scenario type” and choose among these four options:

- General switch: it executes some actions (as per the red scheme) when one or more events (in the green scheme) happen. Using OR logics “if one of the following events happen” or AND logics “if all these conditions are satisfied”;
- Timed scenario: it executes some actions at a certain time (linked to Vesta board time);
- Simple scenario: it works like the general switch, but it has also some disabling conditions. This type of use is suggested only when actions are linked to timing.
- Loads disconnection scenario: in this category, the events which set off the actions are the sum of several consumptions. It is possible to implement this type of scenarios only on installations where consumptions reading boards are present.

Once the type of scenarios has been selected, you can rename it clicking twice on the name. Then, please go to the Elements list, identify the events and the actions to be imported in the scenario and drag them to the proper line. In the green scheme the events are enlisted, while in the red one the actions are enlisted. The last action is to send the scenario to the system, clicking the yellow “gears” icon.

Settings

In the “settings” page, you can configure some parameters of Visus/Tosca. Among them, in the “general” page, some data as Monitor Brightness, Language, Date and Time can be modified.

In the “Network” the IP address linked to Tosca and to the connection status is displayed, in case it is possible to set manually the network parameters in “Properties”.

The settings at “Safety” page are deeply described in the “Safety Management” section.

Utilities

The “Utilities” menu is made up of for sub-items: “Web browser”, “Virtual blackboard”, “Virtual frame” and “Keyboard”.

Web browser

Touch "Web Browser" to open the web navigation section provided by Visus/Tosca.

To navigate, touch the links in the page or use the address bar displayed by touching the last button on the right.

When this bar appears, the Virtual keyboard also appears to enter the address.

Once the URL is entered, touch the green button to load the page; to close the bar, touch the red button. To scroll up/down and right/left in a page, drag the page in the required direction.

The arrow buttons are used to move forward and back between visited pages.

To open a link in another window, drag the link to the lower part of the window (green part).

To return to the home page, touch the UNA logo button.

To save an address as a favorite, touch the star button with a plus sign in the middle. To display the list of favorite sites, touch the "Favorites" button (the yellow star). Touch one of the elements in the list (Figure 24) to open a new window with the linked page.

To eliminate a bookmark, touch the "less sign" button next to the name of the bookmark.

Virtual blackboard

Visus includes a virtual blackboard where you can make quick notes or draw "free hand" using the wide range of markers supplied with the various profiles.

To open the blackboard, select "Blackboard" from the Visus "Utilities" menu. The window that appears represents the drawing area. Touch the displayed window. It will enlarge to let you start drawing.

Three icons appear at the top right of the enlarged window to let you interact with Blackboard controls. Specifically, touch the first icon to display the menu with all available options.

Select the first icon to display the catalogue of markers available in the Blackboard (to select a specific marker, simply touch the icon). The second icon lets you select the size of the marker and color. Select the third icon to create a new drawing area. The fourth icon lets you fully clear the current drawing area and, lastly, the last icon lets you delete the current drawing.

Touch outside the drawing area on a green space or touch the "Blackboard" button in the menu again to display created blackboards in a grid.

Virtual frame

The "Virtual Frame" section lets you set the Visus/Tosca virtual frame mode and shared folder settings where images are stored.

The first checkbox enables or disables the virtual frame function and, if flagged, lets you set the time that must elapse before this mode is enabled and how many seconds the displayed images must last.

The following part is used to set image folder network sharing. The first part lets you change the image access password.

The default password is "samba". The user name cannot be changed and is always "samba".

The following section lets you edit the Workgroup and Visus/Tosca name in the network.

When new names are added, touch "Change" to immediately apply changes.



Figure 19.

How to load images on Visus/Tosca or Visus using a normal PC is described below.

In Windows Xp, open "My Computer" and, from the "Tools" menu, select "Connect network device...".

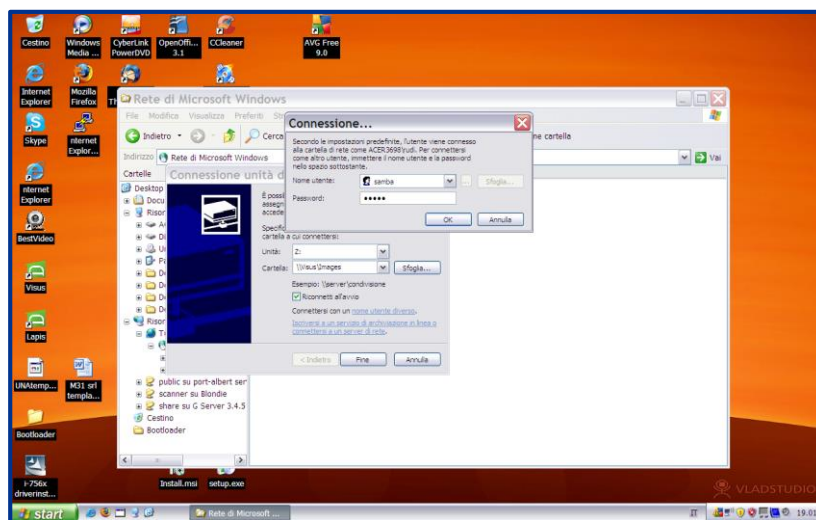

Figure 20.

At this point, the network device settings window appears. Select a letter for the device and enter [\\Visus\Images](#) in the "Folder" field and click "Connect with a different user name" and enter the Visus Virtual Frame user name and password ("samba", "samba" by default). Flag box "Connect at start" and click "End".

At this point, the Visus Images folder should appear.

Normally copy images to the network file so that Visus/Tosca displays them in the next Virtual Frame mode session.

NOTE: if network path [\\Visus\Images](#) is not found, replace the word Visus with the IP address. For example, if the Visus/Tosca IP address is 192.168.1.4, enter [\\192.168.1.4\Images](#).

In **Windows Vista** or **Seven**, open "Network" from the "Start" menu. A list of accessible network devices appears. Double-click VISUS and enter the Visus Virtual Frame user name and password ("samba", "samba" by default). Shared Visus folders are displayed. Right-click Images and select "Connect network device...", click "End".

At this point a network folder was created that can be used as a normal folder.

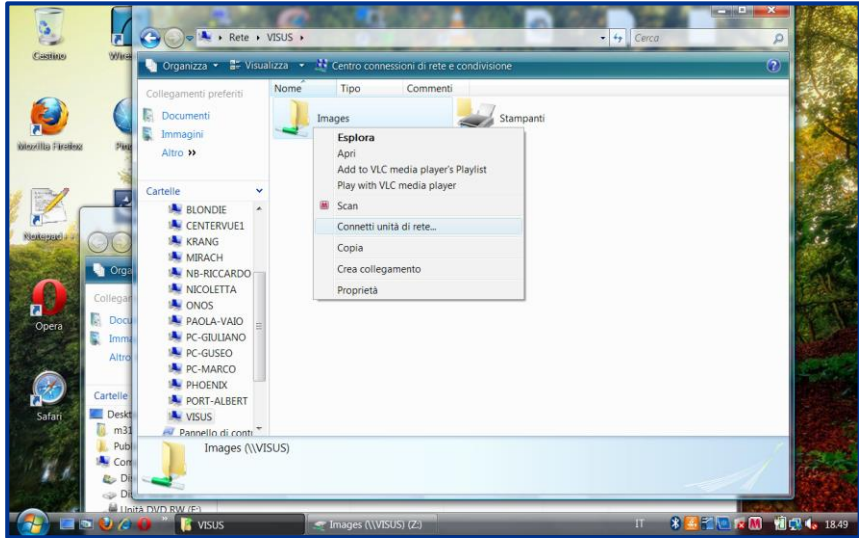

Figure 21.

Keyboard

The virtual keyboard, already presented for the Visus/Tosca registration phase, is necessary for some operations if a keyboard is not installed.

It represents a full 'qwerty' keyboard and is divided in two screens: the first includes all characters and numbers, the second contains all symbols.

You can switch the positions of the two screen by touching the third button on the right (“!?.”). The other buttons are used to close the window, simulate the backspace key and select the window where text is entered.

As for the latter, please note that: it need not be used when the virtual keyboard automatically appears. However, when you press a button to display the keyboard, use this key to position the text generated by the keyboard. For example, if you want to enter the Visus/Tosca password, display the keyboard, touch the key with the target and touch the point on the screen where the TODCA background is visible. At this point, enter the password. The same procedure applies for network settings. The only difference is that the target will be the text box you want to use.



Figure 22.

Security Manager

Security manager allows you to set up a code to disable the devices control of Visus/Tosca by unauthorized users.

Enabling security manager

For enabling the security manager you must follow the steps below:

1. Open administrator menu: Visus/Tosca menu – “Utilities” – “Keyboard”, and insert the installer password (default installer passwords usually are: “999999” or “secret”. If you do not know it, contact the installer).
2. Press “Visus Administrator Settings” icon, it is the last of the right side menu;
3. Enter in the “Security” screen;
4. Enable “Security Manager”.

Later, if you wish, you can set up a time (in seconds), which allows you to control the devices within a limited time without reinserting the code; or reset the administrator security code. See the next figure.

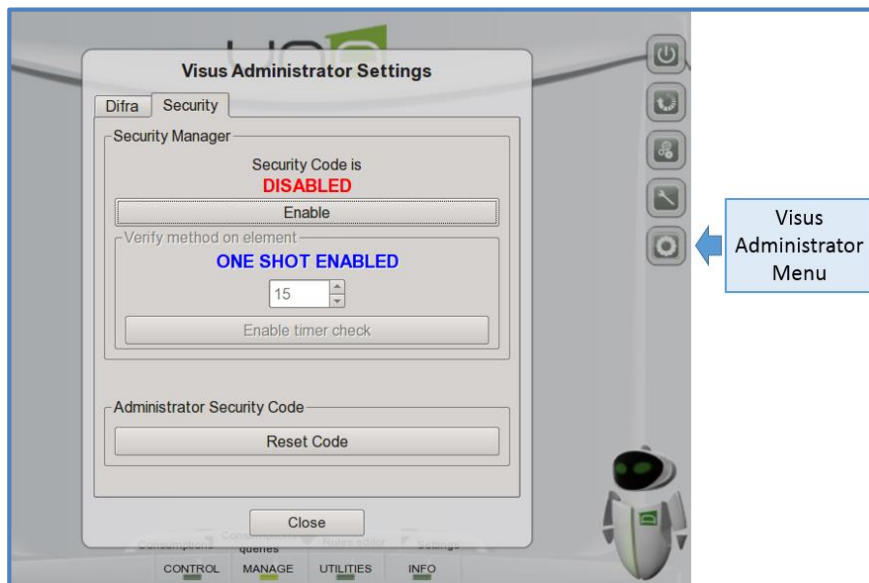

Figure 23.

Enabling users

For enabling a new user, the steps to follow are:

1. Open "Visus Setting" menu: Visus/Tosca menu – "Manage" – "Settings", and key "Security" (Figure 20);
2. Select "Enable" button: a window that warns you will appear, then press "OK" and insert Administration Security Code (default code is: "123456");

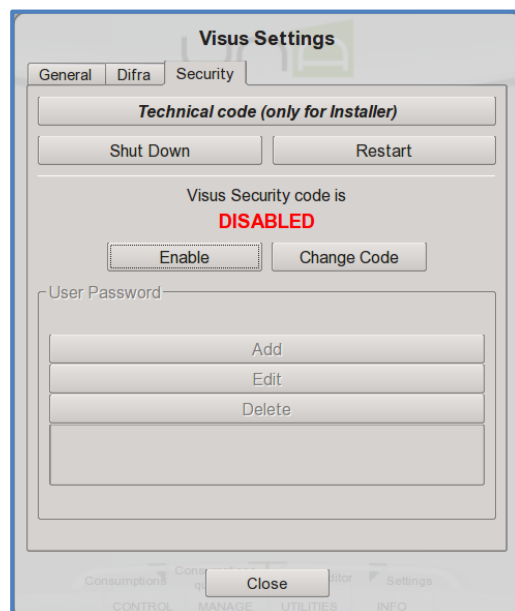

Figure 24.

Now, you can create how many users you want, in order to do that, repeat the following steps for all new users:

1. Press "Add" button and enter the name of the new user;
2. Press "OK" on the new window and insert the Administration Security Code;
3. Repeat step 2, but insert the new user password;



4. Confirm the new user password.

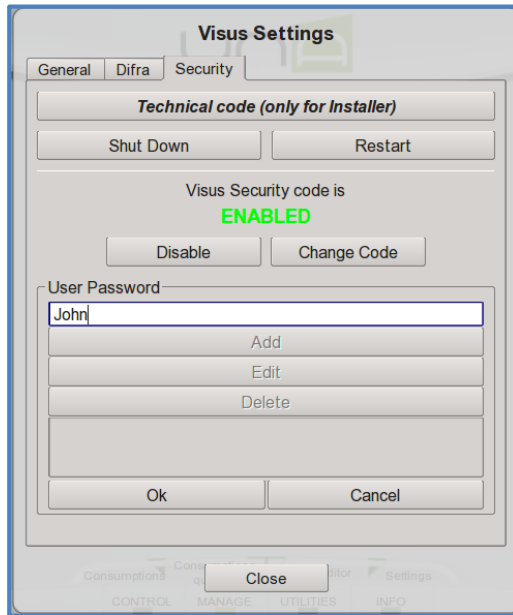

Figure 25.

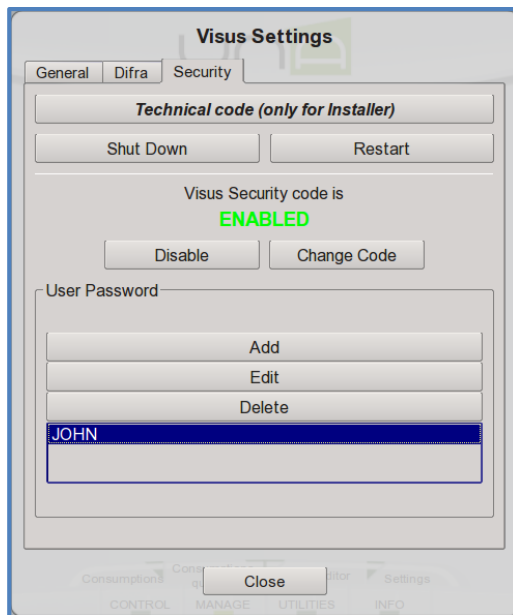

Figure 26.

Prevent the control

By now, on all the elements in the maps, maps included, there is a lock icon that allows you to freeze the status or their settings. In order to do that:

1. Press the lock icon;
2. Press "Modify security configuration";
3. Press "Enable";
4. Select all the users you want to enable;
5. Press "Apply".

If you want to extend this configuration to all the elements of the plant press "Extend to all" button or "Extend to the same type" for extending the settings to all the same elements (i.e. all the lights).

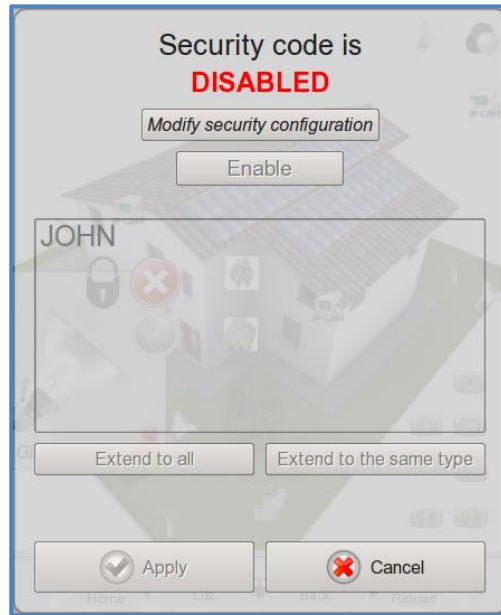

Figure 27.



Figure 28.



Difra Access Control

At Visus/Tosca interface you can directly manage the UNA access control system based on Difra modules. You can control the association of the badge cards to the RFID reader modules (Difra), the activation of electrical locks, turn on/turn off the courtesy lights and monitoring the presence in the room.



WARNING: the management software has been designed to be executed in only one system at a time, for this reason it has to be habilitated in only one Visus/Tosca in the installation, otherwise some conflicts may happen. Even the code's memorization is referred only to the device you are work with, therefore if you will change Visus/Tosca, you will lose the saved codes.

Difra Manager

The first operation is to enable the Visus/Tosca device to Difra access control, you have to enter in the installer menu: Visus/Tosca menu- "Utility"- "Keyboard" and type the installer password (the default password is "999999" or "secret". If you don't have the password, please call the installer).

From the vertical menu in the right side of the screen, select the last icon "Visus/Tosca Administrator Settings"



. In the Difra's window please select "Enable" and type "OK" in the warning windows that will open. See next picture.

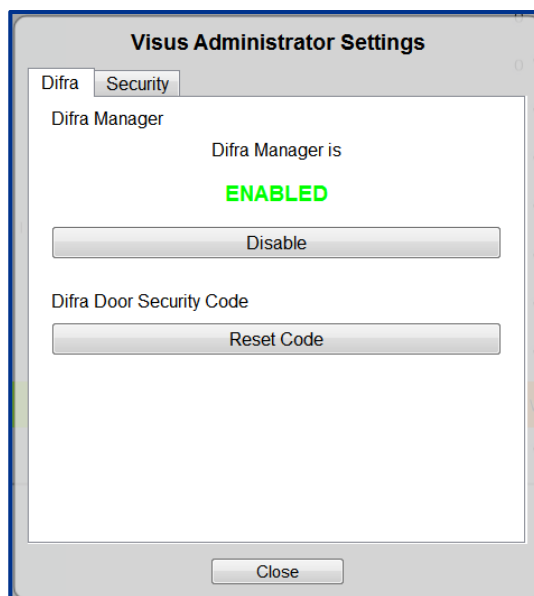

From this window you can also reset the “Difra secure code”, replacing the code in use with the default one “123456”.

Difra secure code



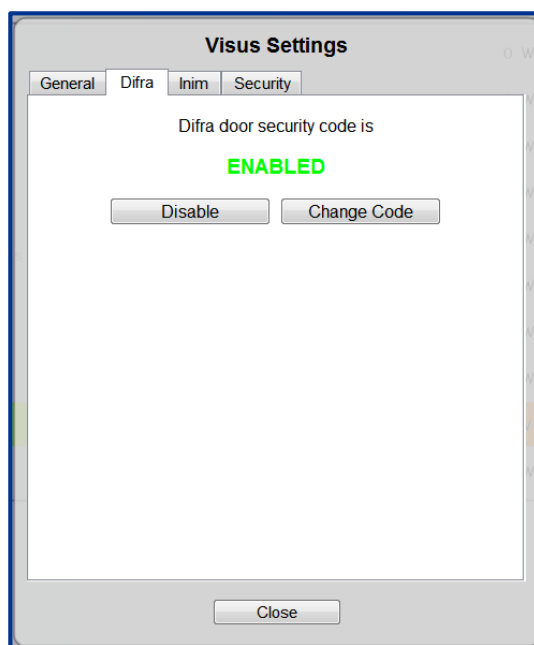

When it’s enabled, Difra secure code will prevent the control of all Difra’s elements to the users who do not have it. It is possible enable/disable or change the codes at the Settings page: Visus/Tosca menu- “Manage”- “Settings”-“Difra”; for each one of these operations you have to insert the secure code in use. See the next picture.



Modes and principal functions.

Selecting a badge reader from a map, it is possible to display its status. The representation is matching with the real aspects of Difra, in which four different LED lights resume the different status:



	Enabled access: green LED; access denied: red LED light.
	Presence in the room: yellow LED light
	Power supply: red LED light.
	Do not disturb: yellow LED light.

Pressing on the icons on the lower side, two simple controls can be activated:

- Open the door's room;
- Turn on the courtesy light.

Statistics and programming.

In the Visa/Tosca management of access control, there are two different configurations of Difra's modules:

- Difra master module (red icon) is used only for badge codes and to save them in the system. Usually it is placed at the reception's zone.
- Difra slave module (grey icon): used for the validation of badge cards and for access control.



Clicking in the centre of the icon of the Difra element, the management system will open the first window that opens is about the list of all the Difra cards in the installation.

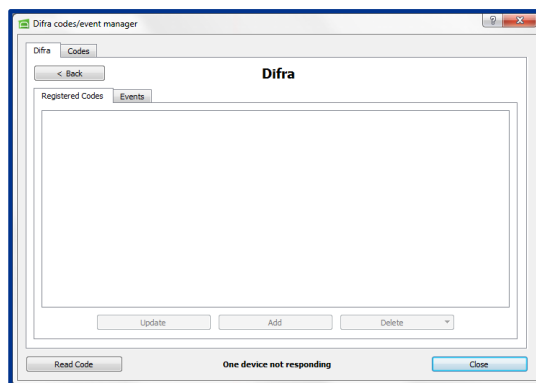

NOTE: In case of malfunctioning of a Difra board, the errors will be underlined in red.

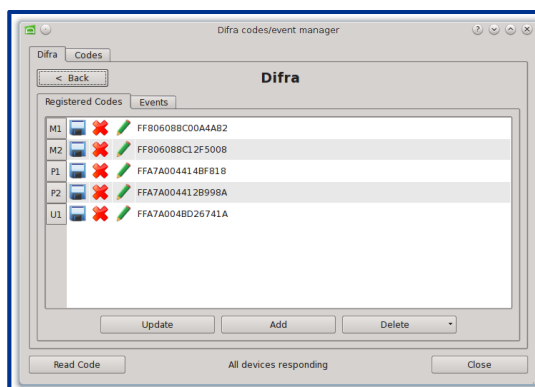

Selecting a Difra board and clicking on "Show" the following page will open, and you will see all the badge codes associated to the Difra board.



For each badge card saved in a Difra badge, the following actions associated to these icons are allowed:

	Save badge card with a name.
	Delete the association between Difra and a badge.
	Replace the code with another code. The new badge card could be an old one, or a new code could be inserted manually.

NOTE: when you associate the badge cards to a Difra board, they are saved following this order:

- First two cards: Main badge cards;
- Further two cards: cleaning badge cards;
- Further cards: users' cards (2 is a default number, it can be modified by the installer in case he has to design).

When a badge card is deleted from the association to a Difra, the other cards climb up of a position and replace the function of the previous badge card (for example: changing from user card to cleaning staff card or cleaning staff to Main badge cards).

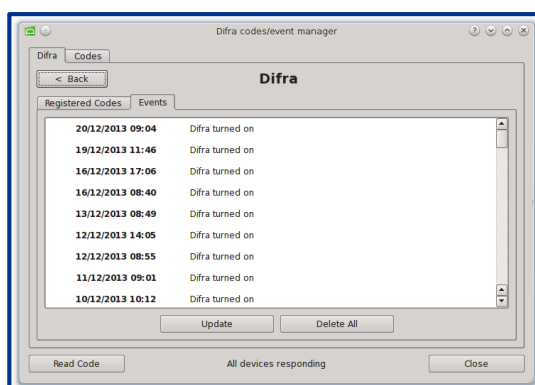

Clicking the button "Events" you can see the history report of all the actions related to Difra.

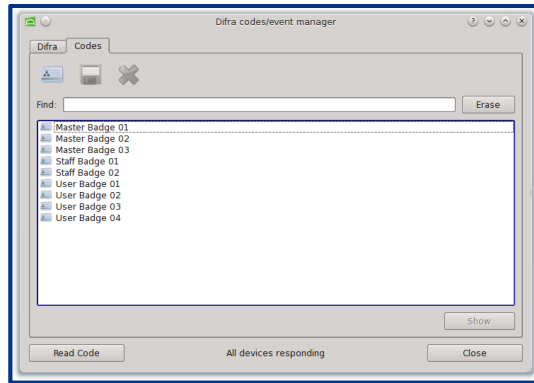

Selecting "Codes" all the codes related to the badge cards are saved in the management software.



The icons on the top on the left, have the following functions:

	You can insert a new badge card writing manually name and codes.
	You can rename a code already saved.
	You can delete a new badge card form the management software.

Select a code, then push the “Show” button to see all the codes. This operation displays all the Difra badge cards where the badge card is saved.

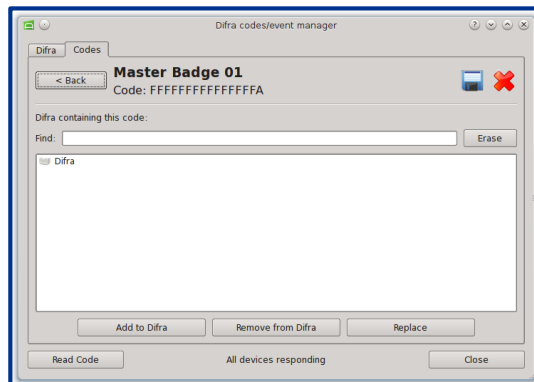

New badge card

Using Master Difra, clicking on the “Read codes” button, this code is waiting to be associated to a badge card.



After reading the serial alphanumeric identification number in the badge card, you can save the code and associate it with one or more Difra readers present in the installation.



SIDERA HOME

SideraHome is a web application that allows to control the devices of your UNA System installation through a standard residential network. Thanks to it, you can turn on/turn off the lights, lift shutters, regulate the temperature, see how much energy your washing machine is using and much more.

You can enter it through a common browser (Internet Explorer 9+, Firefox, Chrome, Safari, etc.) and through tablets/smartphones (iOS, Android) downloading the UNAMobile app from the app store. It is not necessary to have an Internet connection to benefit of all these features, because the system takes advantages of a cabling/wireless network in the installation.

Once you have connected to the same sub network where Vesta board is, in order to enter the web interface using the browser, please type the (IP) address in the address bar. Using the app, you will automatically see the Vesta boards present on the net.

SideraHome Menu

SideraHome is divided in several pages to help the navigation in the web-server. You can enter from the menu on the top, among them you will find:

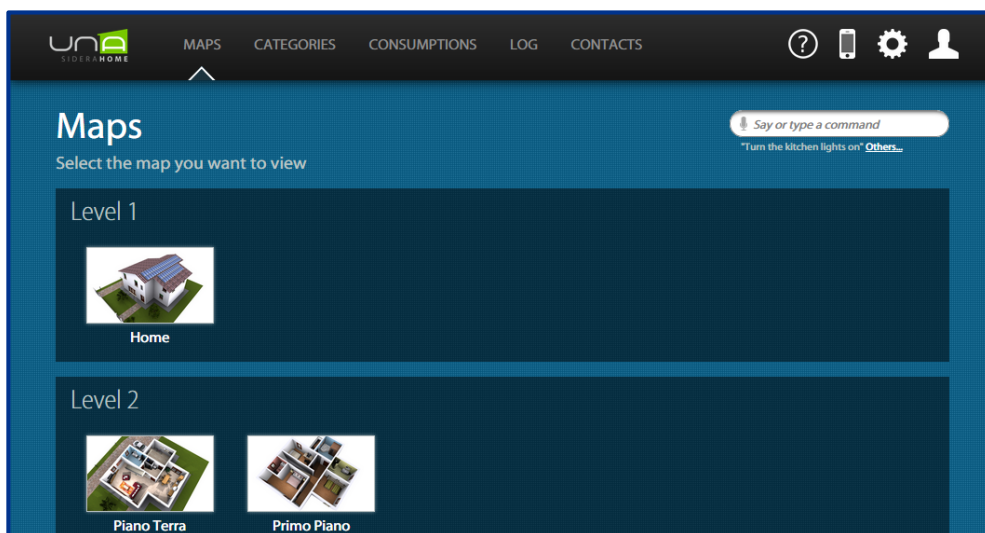

Maps

In the Maps page, the areas of the house from the main areas onwards are listed. Among them, you will find all the status elements and controllable as icons. Clicking on them, a box will appear with information about the current status of the device, and with actions you can perform.

Under the map a list with the maps related to the visible one will be displayed.

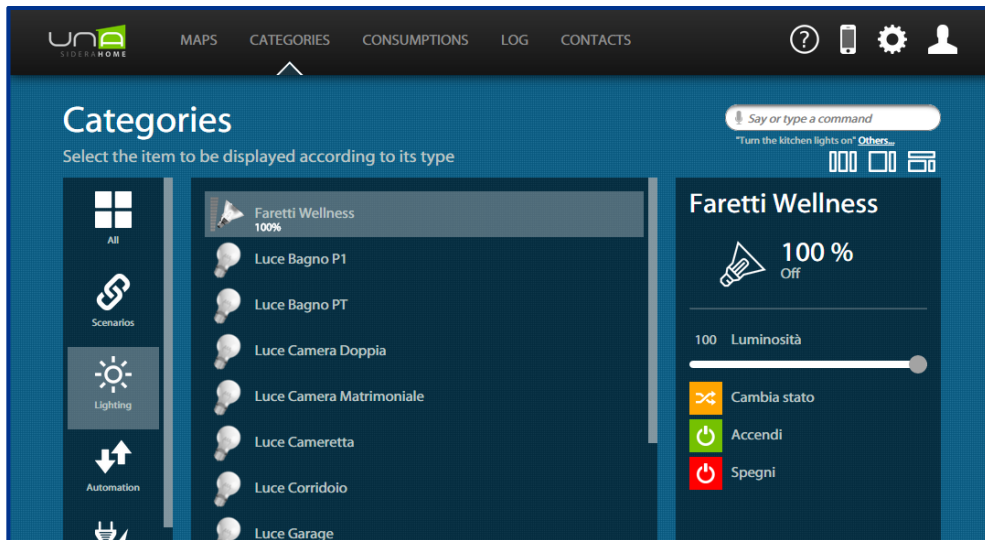

Categories

The categories are an alternative view to the maps ones, where the devices are organized by type and not by location. The most common categories are “Lighting management” and “Thermoregulation and climate”, etc... In the upper right side, you can change the layout of the panes by selecting one of the three options (desktop version only).

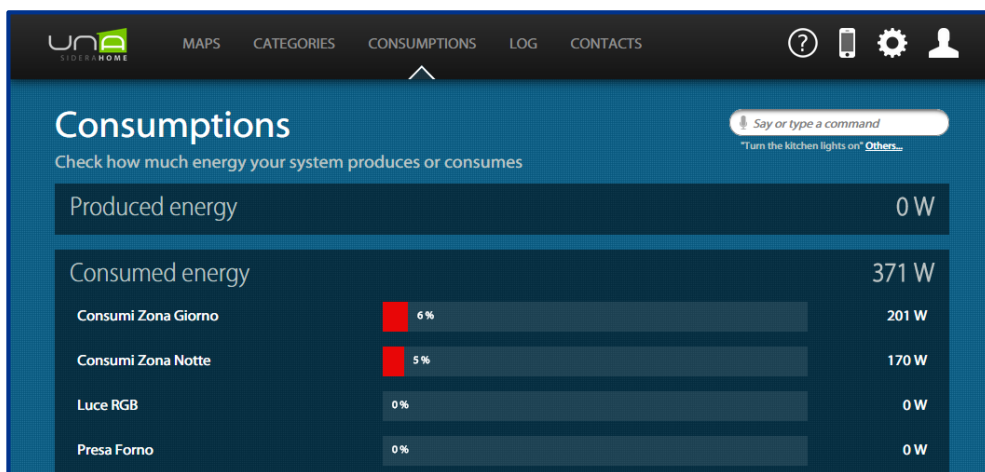

Consumptions

In this page the consumptions of the monitored devices are displayed. The devices are divided in two sections depending on the fact that they will produce or consume energy.

By clicking on each line of the list, a history report will appear. It can be hourly, daily, weekly, and monthly during the most recent time (it requires a SD badge card to be inserted in the Vesta board).

As an alternative, the buttons below offer the possibility to export and download these values in a CSV file (readable by Excel) and manage the database of energy consumptions.

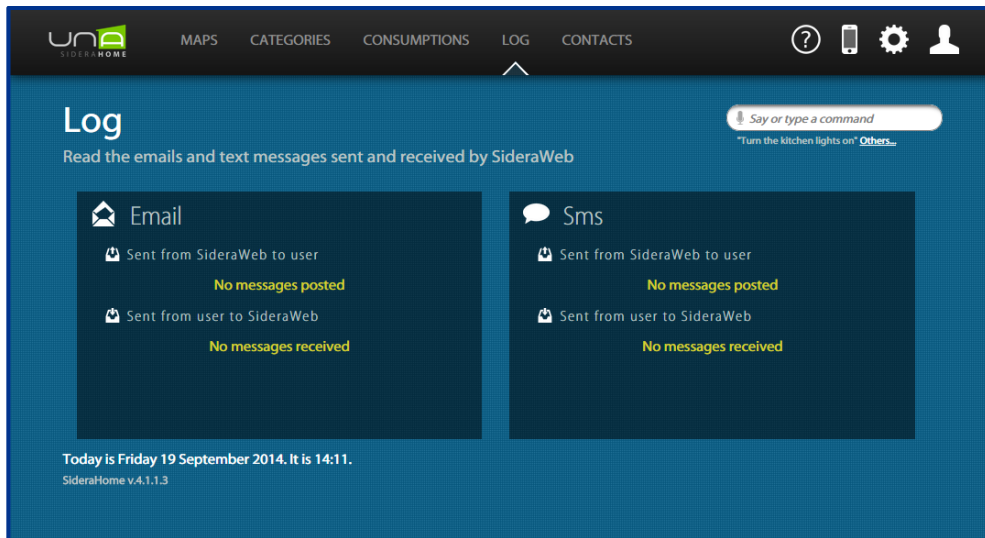

Log

In the Log page you can read messages (emails and SMS texts) exchanged between SideraHome and SideraWeb service in order to get a feedback on the events of the installation.

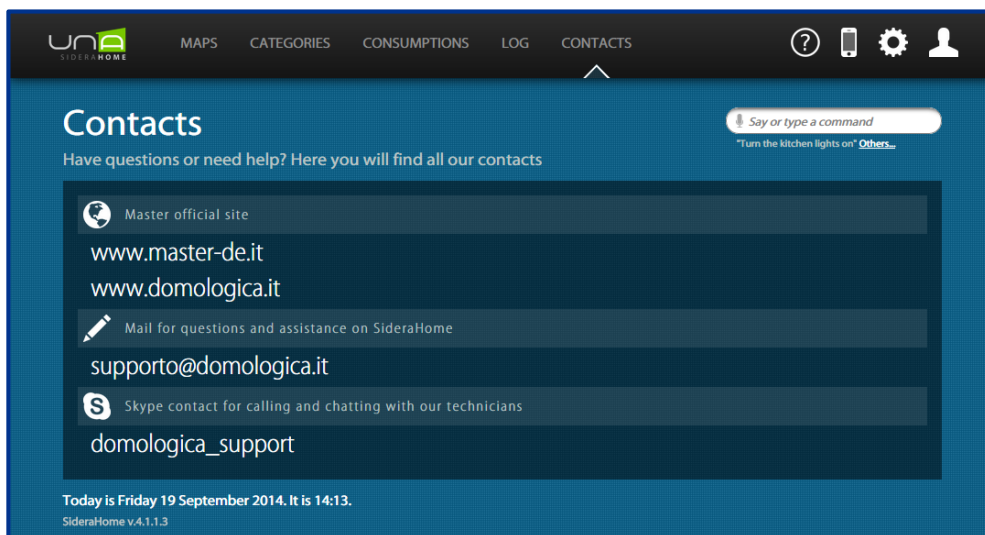

Contacts

It allows you to view web pages and links to resources for get assistance and news related to products and manufacturers.

Versions

SideraHome automatically adapts to the screen size depending on whether the device is a smartphone or a desktop. If you prefer always to use the same version, you can set it with one of the following:

- **Mobile:** for tablet/smartphone screens;
- **Desktop:** for bigger screens, such as computers or televisions;
- **Mixed:** SideraHome will automatically adapt to the screen size settings by setting one of the previous ones.

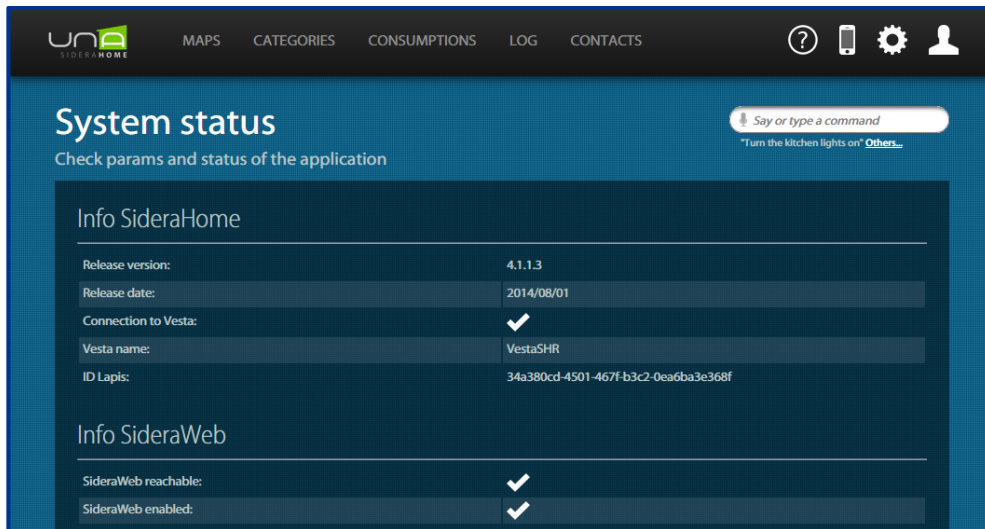

System

This section is dedicated to the installation administrators. There is a list of some information about SideraHome and SideraWeb, as well as tools such as clock and restart/reset.

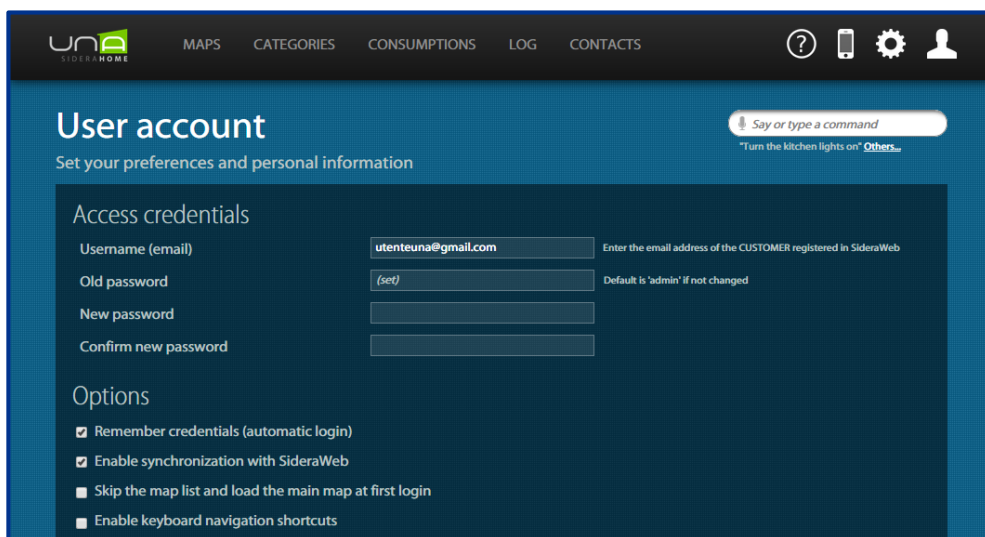

Users

In this page all the parameters and the preferences that can be set are resumed.

You can manage your user name and password that serve as access protection of SideraHome on the top. If you enable synchronization with SideraWeb, for the options below you must ensure that your user name and password will match with those used in the SideraWeb portal: it will be also impossible to synchronize them and monitor the system by remote control.

These options are:

- **Save data:** it makes the access to SideraHome possible without entering user name and password to a new login;
- **Enable SideraWeb:** it allows the remote control of the system (this operation requires Internet connection);
- **Skip the maps:** it allows direct access to the main map, visiting the Maps page;
- **Navigation with keyboard:** it provides support to use SideraHome only with keyboard.
- **Notes:**
 - Case sensitive, distinction between capital letters and normal letters while typing keys;
 - To select an item without nearby letters, please press the Tab key many times;

- The selected object is highlighted with a red color;
- Use the Esc key to deselect an object.

Other options:

- **Default version:** it is possible to set a default view for each access;
- **Colour:** set the background color of the application;
- **Language:** it is possible to configure the application's language among the available applications.

Semantic commands

There is a text bar in each page who has the aim to execute commands with the use of phrases in 'natural language'. Writing for example "Turn on the light in the kitchen" the command 'Turn on' will be sent to the element of the project called 'Kitchen Light'.

You can type words on the bar, or if you have a tablet/smartphone with voice support (e.g. Siri for iOS), you can vocally say the command.

In order to have other examples and all the available commands, please click on "More..." under the text bar.

SIDERA WEB

SideraWeb makes navigation, interaction and the control of all the UNA System possible by remote control through any network device provided with a web browser and an internet connection.

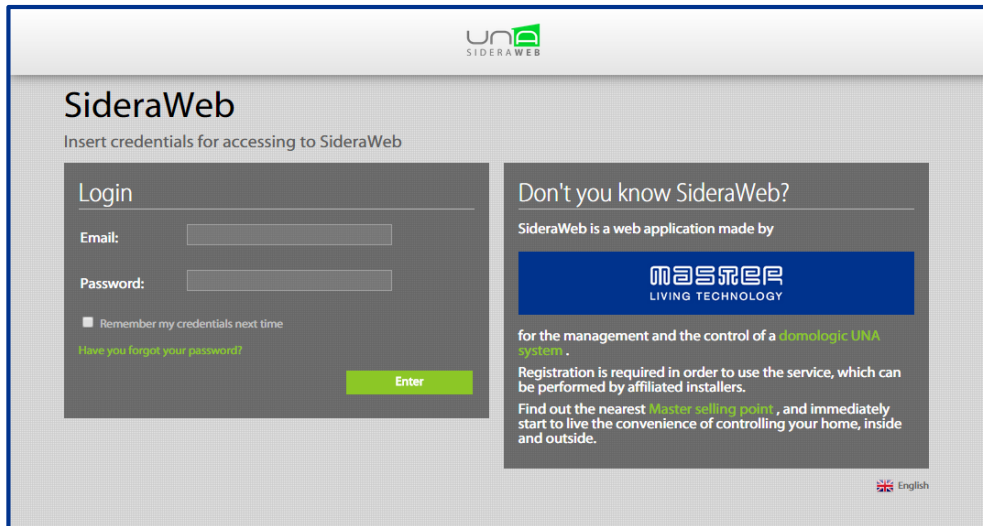

In order to access to this service, please go to the website sidera.domologica.it with an account certified by the distributor of the service. This account is provided by the installer and must be the same used in the SideraHome application; for further information please refer to the User section in the SideraHome chapter.

SideraWeb Menu

After the login, the SideraWeb's menu is displayed, it is consisting of three pages: Installations, Users and Support.

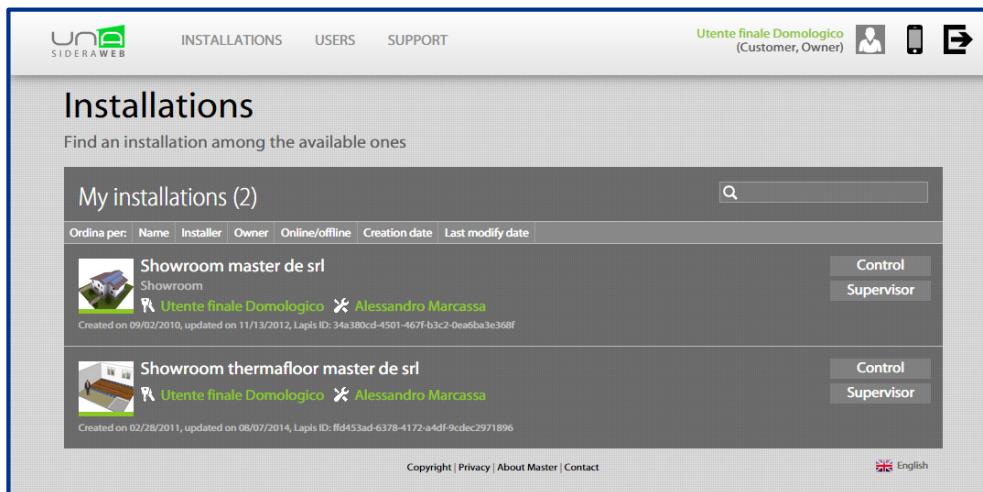

Installations

The installations page shows all the installation associated to the user. Through the Control button at the side of each installation, an interface will appear. It is very similar to SideraHome and from here, you can display and control the installation.

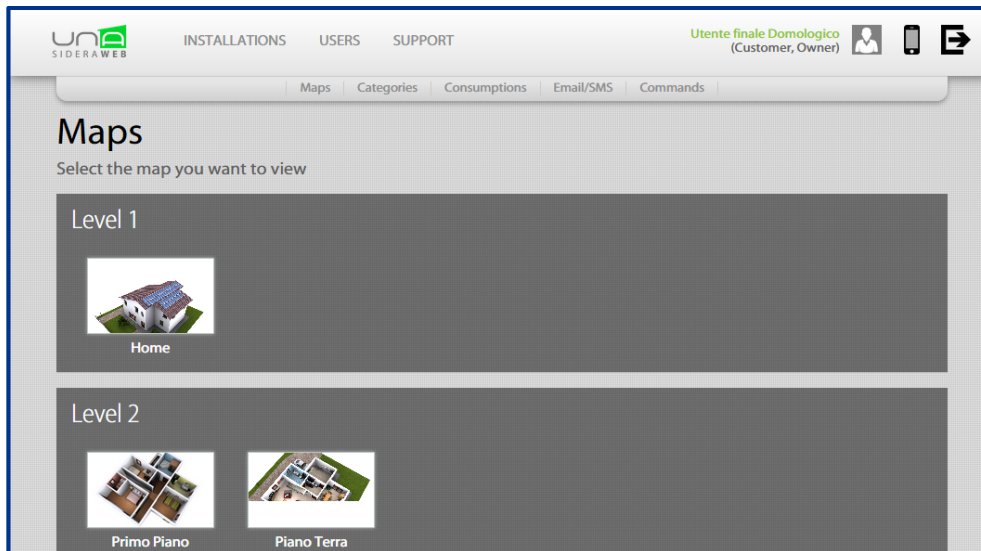

The sub-menu on the top, makes navigation easier thanks to the below pages:

- **Maps:** in which the areas of the house are enlisted, hierarchically distributed from the main onwards. Among them are all the elements directly inspectable and controllable, as icons. Clicking on them, a box will appear with information about the current status of the device and the actions you can perform;
- **Categories:** it is an alternative view to the one of the maps, the devices are organized by type not by location;
- **Consumptions:** shows the power consumptions of the monitored devices. The devices are divided into two sections depending on whether they consume or produce energy. By clicking on each item in the list, a history report will appear. It can be hourly, daily, weekly, and monthly during the most recent time (a SD card in Vesta board must be installed). As an alternative, you can download these values in a CSV file (readable by Excel).
- **Email/SMS:** where you can check the correct transmission of messages and emails through the SideraWeb portal, if scenarios that use them have been implemented;
- **Commands:** where you can check the status of the last commands sent.

Through the “**Manage**” button you have the possibility to enable your installer or the tenants to access and control the installation for a limited time (to create a 'Tenant' profile, see Users section).

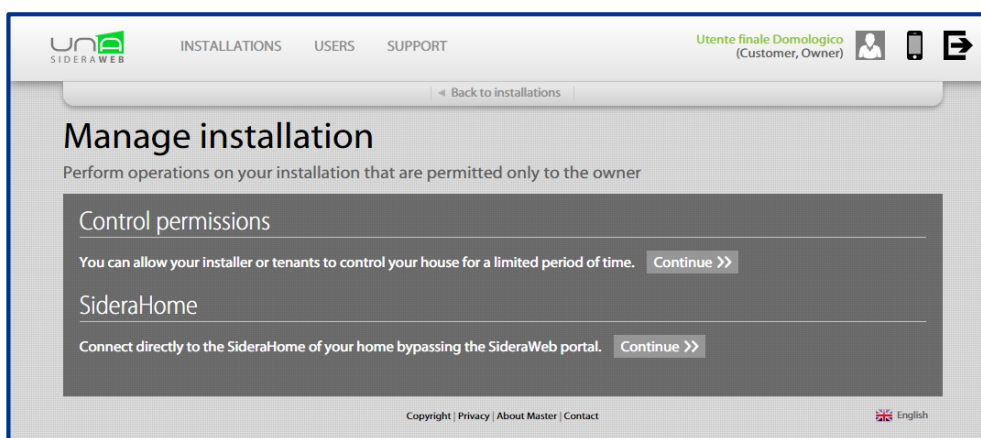

Another tool on this page allows you to bypass the SideraWeb portal, clicking on Continue a quick guide to the opening of the ports on the router will open.

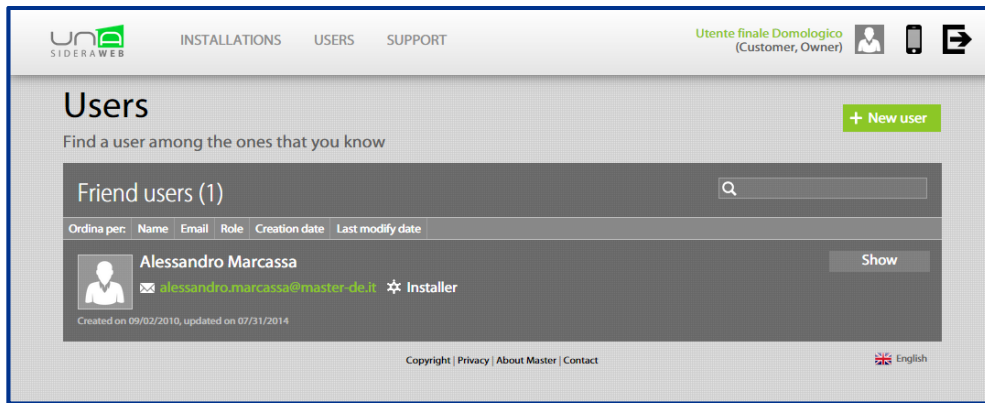

Users

This page shows all users logged in your account: installers, owners and tenants.

To create a tenant account, please press the **New user** green button and provide all the required data. Once completed, in order to link it to an installation, please enter the **Installation page**, click on **Manage** and **Continue** on 'Permissions control'. Then please click on the green button **Enable user**, choose the user you wish to enable, set a time of validation, and save to confirm.

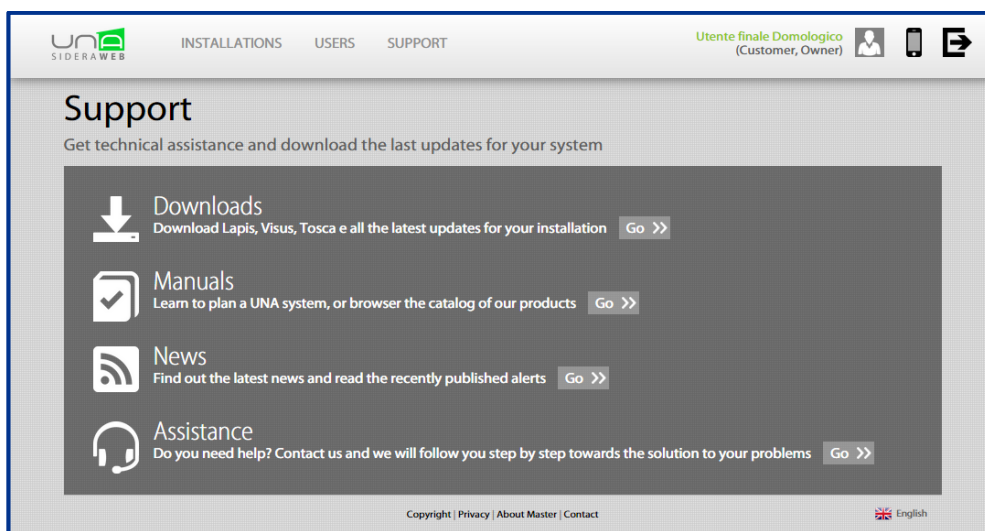

Support

On this page you can download all the software you need to keep your system updated and manuals for details. Our News section contains service communications and notices of new releases. The last element offers different options to contact us and receive assistance support in case of need.





www.domologica.com

Master S.r.l. Divisione Elettrica

Via Mario Tognato 16, 35042 Este [Pd] Italia
T +39 0429 602 777 – F +39 0429 601 247
P. IVA IT 00764990289
master@master.it – www.master.it

Master Pom Electricals Trading Llc

Office # 809, Tameem House
Tecom (Dubai) - U.A.E.
Tel. +971 4 4498 400
Fax +971 4 4498 411
www.master-de.ae

MASTER
LIVING TECHNOLOGY